

### Professional Weather Center

model 02064C / 999143



#### CONTENTS

Unpacking Instructions .....	2	5-in-1 Sensor Installation.....	12
Package Contents .....	2	Using the Weather Center .....	13
Product Registration .....	2	Rainfall Tracking .....	14
Features & Benefits: 5-in-1 .....	3	Weather Ticker .....	15
Features & Benefits: Display....	4	Troubleshooting .....	16
Setup .....	7	Care & Maintenance.....	19
5-in-1 Sensor Setup .....	7	Calibration .....	20
Display Unit Setup .....	8	Specifications.....	21
AcuRite Connect .....	9	FCC Information .....	21
Set the Time, Date & Units .....	10	Customer Support .....	22
Backlight Settings.....	10	Warranty.....	22
Placement Guidelines .....	11		

**Questions?** Contact Customer Support at (877) 221-1252 or visit [www.AcuRite.com](http://www.AcuRite.com).

**SAVE THIS MANUAL FOR FUTURE REFERENCE.**

# ACURITE®

Congratulations on your new AcuRite product. To ensure the best possible product performance, please read this manual in its entirety and retain it for future reference.

## Unpacking Instructions

Remove the protective film that is applied to the LCD screen prior to using this product. Locate the tab and peel off to remove.

## Package Contents

1. Display unit with tabletop stand
2. 5-in-1 sensor
3. Sensor mounting bracket
4. Mounting hardware
5. Power adapter
6. USB cable
7. 4 alkaline batteries
8. Instruction Manual

## IMPORTANT

PRODUCT MUST BE REGISTERED  
TO RECEIVE WARRANTY SERVICE

### PRODUCT REGISTRATION

Register online  
to receive 1 year  
warranty protection

[www.AcuRite.com](http://www.AcuRite.com)

SHOP NOW

SUPPORT

Support Forum

Archived Products

▶ Register a Product

# Features & Benefits

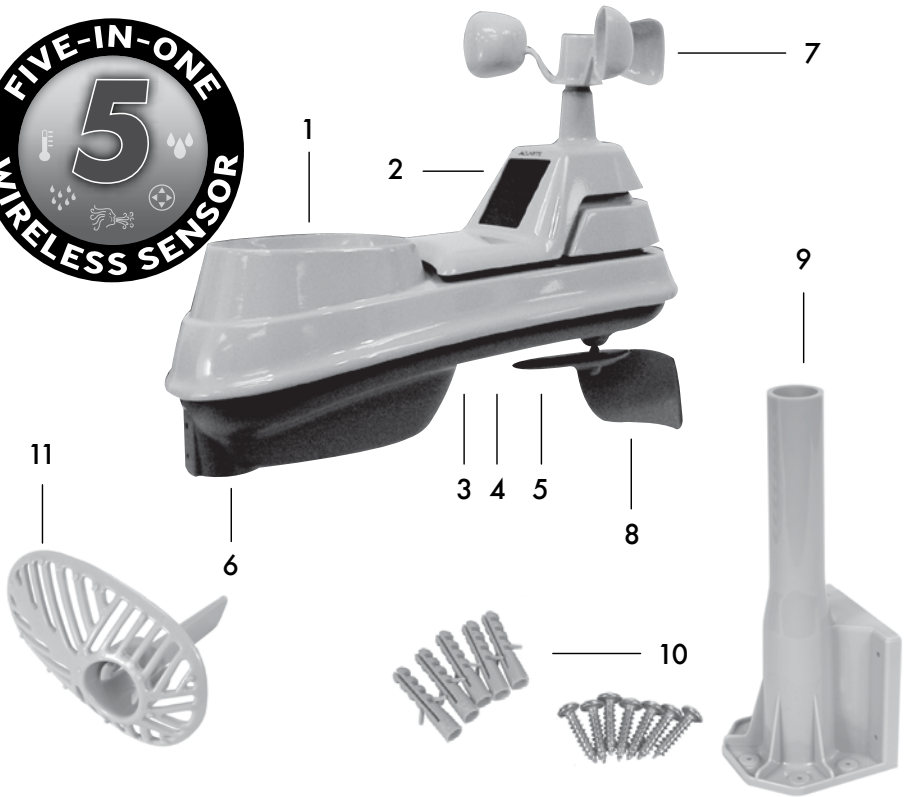

## 5-in-1 SENSOR

### 1. Rainfall Collector Funnel

### 2. Solar Cell Panel

Converts sunlight into power to run internal aspirating fan.

### Internal Aspirating Fan (not shown)

Draws ambient air into sensor to reduce solar radiation heating, resulting in more accurate temperature measurement.

### 3. A-B-C Switch

ID code that must match display's A-B-C switch to ensure units synchronize.

### 4. Battery Compartment

### 5. Temperature & Humidity Sensors (internal)

### 6. Mounting Point

### 7. Wind Speed Anemometer

### 8. Wind Direction Vane

### 9. Mounting Bracket

### 10. Mounting Hardware

Includes anchors & screws.

Qty	Diameter	Length
5	#4	3/4"
1	#4	1/2"
1	#6	1/2"

### 11. Debris Filter

Pre-installed to prevent debris from entering the rain gauge.

# Features & Benefits

## Display Unit

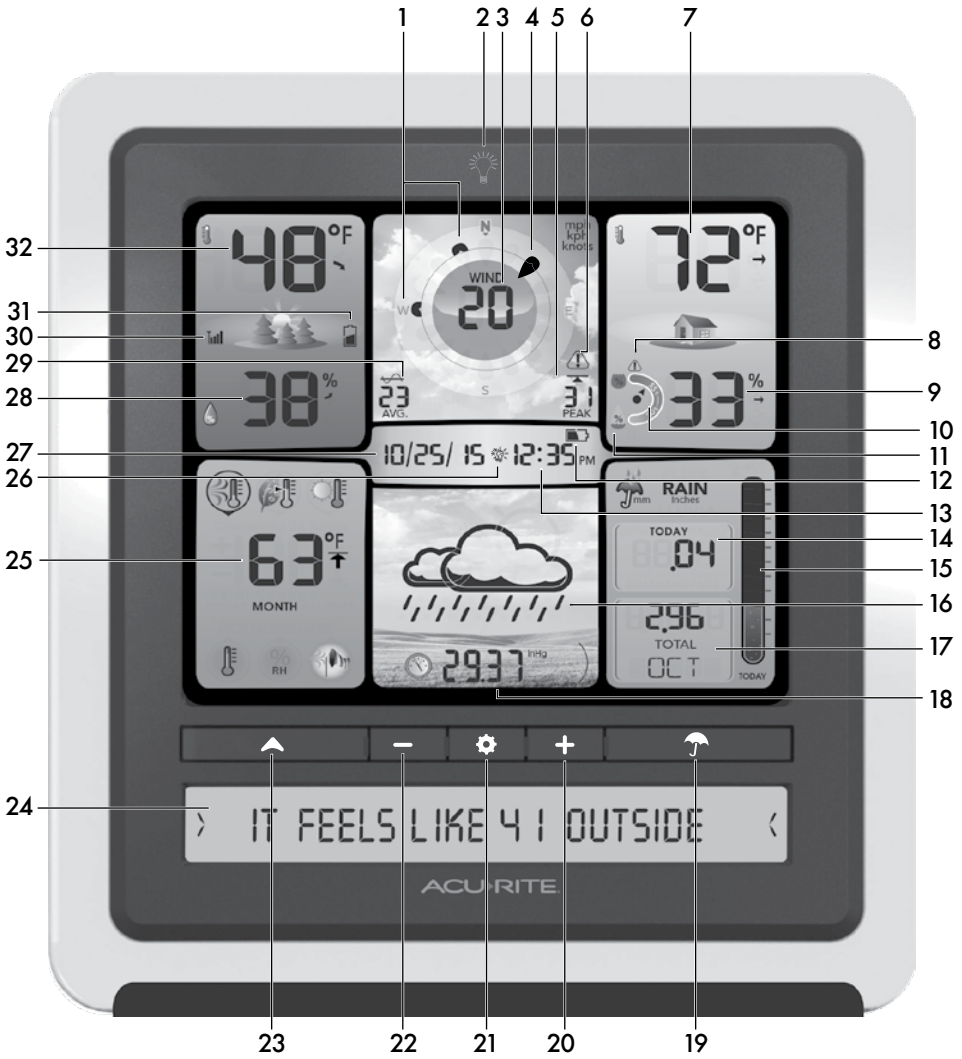

- 1. Previous 2 Wind Directions**
- 2. Backlight Button**  
For momentary backlight and dimmer settings.
- 3. Current Wind Speed**
- 4. Current Wind Direction**
- 5. Peak Wind Speed**  
Highest speed from the last 60 minutes.
- 6. High Wind Speed Icon**  
Indicates peak wind speed is greater than 50 MPH (81 KPH).
- 7. Current Indoor Temperature**  
Arrow icon indicates direction temperature is trending.
- 8. High Indoor Humidity Icon**  
Indicates indoor humidity level is greater than 75% RH.
- 9. Current Indoor Humidity**  
Arrow icon indicates direction humidity is trending.
- 10. Humidity Level Indicator**  
Indicates a high, low, or ideal indoor humidity comfort level.
- 11. Low Indoor Humidity Icon**  
Indicates indoor humidity level is below 16% RH.
- 12. Display Low Battery Icon**
- 13. Clock**
- 14. Rainfall**  
Displays rainfall total for TODAY, this WEEK, or this MONTH.
- 15. Today's Rain Indicator**  
Illustrates rainfall collection up to 1 inch (25 mm).
- 16. 12 to 24 Hour Weather Forecast**  
Self-Calibrating Forecasting pulls data from your 5-in-1 sensor to generate your personal forecast.
- 17. Rainfall History**  
Displays historical rainfall totals (see page 14).
- 18. Barometric Pressure**  
Arrow icon indicates direction pressure is trending.
- 19. "☂" Button**  
Changes the rainfall data being displayed (#17).
- 20. "+ " Button**  
For setup preferences and manually cycling through Weather Ticker messages.
- 21. "⚙" Button**  
for setup preferences.
- 22. "—" Button**  
For setup preferences and manually cycling through Weather Ticker messages.
- 23. "▲" Button**  
Changes the WEATHER SELECT category (#25) being displayed.
- 24. Weather Ticker™**  
Streams real-time data (see page 15).
- 25. WEATHER SELECT**  
Displays high/low records and seasonal data (see page 13).
- 26.  AUTO DIM Icon**  
Indicates display is in auto-dimming brightness mode. (see page 10)
- 27. Date**
- 28. Current Outdoor Humidity**  
Arrow icon indicates direction humidity is trending.
- 29. Average Wind Speed**  
Taken from all wind speed readings over the past 2 minutes.
- 30. 5-in-1 Sensor Signal Strength**
- 31. Sensor Low Battery Icon**
- 32. Current Outdoor Temperature**  
Arrow icon indicates direction temperature is trending.

## Back of Display Unit



### BACK OF DISPLAY UNIT

- 1. Plug-in for Power Adapter**
- 2. Plug-in for USB Cable**
- 3. Integrated Keyhole**  
for easy wall mounting.
- 4. MAC ADDRESS**  
12 digit unique ID required for online connectivity functions.
- 5. Backup Battery Compartment**
- 6. A-B-C Switch**  
ID code that must match 5-in-1 sensor's A-B-C switch to ensure units synchronize.
- 7. CLEAR RECORD / RESET Button**  
Press to clear data recorded since 12:00 am. Press and HOLD for full reset to factory defaults.
- 8. Power Adapter**
- 9. USB Cable for PC Connection**
- 10. Battery Compartment Cover**  
(not shown)

## 5-in-1 Sensor Setup

### 1 Set the A-B-C Switch

Locate the A-B-C switch inside the battery compartment. Set the A-B-C switch to A, B or C. You must select the same letter choices for both the sensor and the display unit in order for the units to synchronize.

### 2 Install or Replace Batteries

Batteries **MUST** be installed for this product to operate. AcuRite recommends high quality alkaline or lithium batteries for the best product performance. Heavy duty or rechargeable batteries are not recommended.

The 5-in-1 sensor requires lithium batteries in low temperature conditions. Cold temperatures can

cause alkaline batteries to function improperly. Use lithium batteries in the 5-in-1 sensor for temperatures below -4°F / -20°C.

1. Slide off the battery compartment cover.
2. Insert 4 x AA batteries into the battery compartment, as shown. Follow the polarity (+/-) diagram in the battery compartment.
3. Replace the battery cover.

### 3 Remove Rain Gauge Stabilizer

Locate and remove the rain gauge stabilizer (plastic tab) taped into the bottom of the sensor. The rain gauge will not function until this is removed.

**LITHIUM BATTERIES** -40°F (-40°C) (70°C) 158°F

**ALKALINE BATTERIES** -4°F (-20°C) (70°C) 158°F

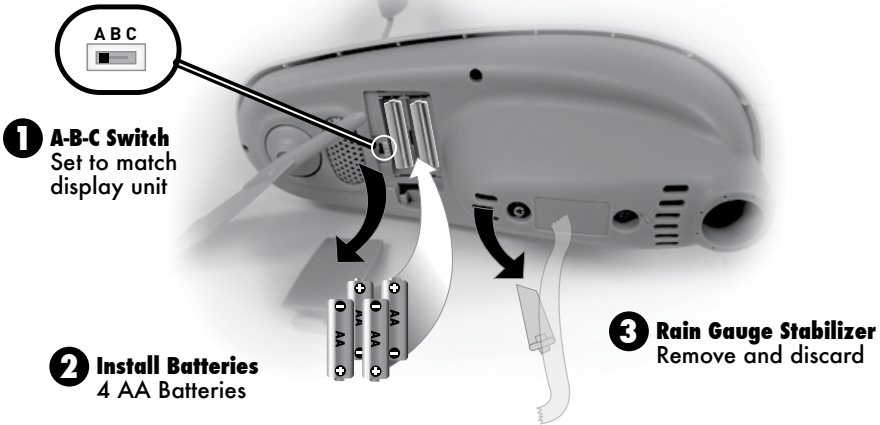

# Display Unit Setup

## 1 Set the A-B-C Switch

The A-B-C switch is located inside the battery compartment. It can be set to A, B or C. However, you must select the same letter choices for both the sensor and the display unit in order for the units to synchronize.

## 2 Plug Power Adapter into Electric Outlet

## 3 Write Down the MAC ADDRESS

12 digit unique ID needed for online connectivity functions.

**24 C8 6E**

## 4 Install or Replace Backup Batteries (optional)

Insert 3 x AA alkaline batteries into the battery compartment, as shown. Follow the polarity (+/-) diagram in the battery compartment.

### 1 A-B-C Switch set to match sensor

A B C

### 3 Write Down MAC ADDRESS 12 digit number

### 4 Install Backup Batteries 3 AA Batteries



### 2 Plug in Power Adapter



**IMPORTANT:** Batteries are a backup power source to preserve records in the event of a power outage. Power adapter is the recommended primary power source to enjoy the full functionality of this product.



**PLEASE DISPOSE OF OLD OR DEFECTIVE BATTERIES IN AN ENVIRONMENTALLY SAFE WAY AND IN ACCORDANCE WITH YOUR LOCAL LAWS AND REGULATIONS.**

**BATTERY SAFETY:** Clean the battery contacts and also those of the device prior to battery installation. Remove batteries from equipment which is not to be used for an extended period of time. Follow the polarity (+/-) diagram in the battery compartment. Promptly remove dead batteries from the device. Dispose of used batteries properly. Only batteries of the same or equivalent type as recommended are to be used. DO NOT incinerate used batteries. DO NOT dispose of batteries in fire, as batteries may explode or leak. DO NOT mix old and new batteries or types of batteries (alkaline/standard). DO NOT use rechargeable batteries. DO NOT recharge non-rechargeable batteries. DO NOT short-circuit the supply terminals.



## AcuRite Connect

AcuRite Connect works with Windows PC's to provide access to your Weather Center data in the following ways:

- **Data File:** Display unit logs (or stores) data so that you can download it to a PC in a data file (CSV, or comma-separated values file).
- **Web Browser or Smartphone:** Monitor sensor data remotely using AcuRite's free AcuRite online software, or from a mobile device using the free AcuRite app, available from the iOS App Store or Google Play Store.

## Download the Software

The AcuRite Connect software is available online as a free download. A manual (PDF) is included with the software download.

- 1 Download AcuRite Connect software to your computer by visiting:  
**<http://www.acurite.com/kbase/downloads/>**

Or, navigate to the link above using the following path:  
www.acurite.com > Support > Downloads

- 2 Click the .exe file that was downloaded in step 1, and follow the on-screen instructions to install the software. A folder named "AcuRite Weather Station" will be installed on the computer.

- 3 After AcuRite Connect is installed on the computer, open the AcuRite Connect app. Verify that the display unit is ON with the power adapter plugged in. Next, connect the mini-USB (small end of the cable) into the USB port on the display, located inside the battery compartment.

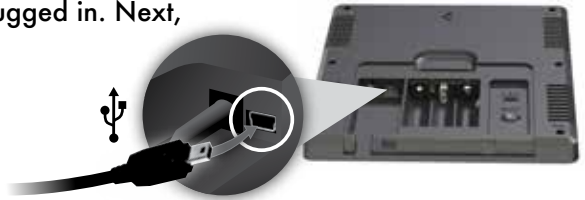

Connect the USB (larger end of the cable) into a USB port on a Windows computer.

- 4 **AcuRite Connect is installed and ready for use.** Follow the instructions within the AcuRite Connect app to complete setup and begin using the software.

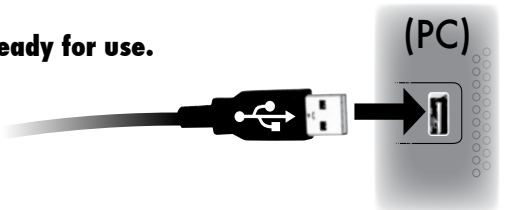

## Set the Time, Date & Units

Press the “” button, located on the front of the display unit, to enter SET MODE. Once in set mode, the preference you are currently setting will blink on the display.

To adjust the currently selected (flashing) item, press and release the “+” or “-” buttons (press and HOLD to fast adjust).

To save your adjustments, press and release the “” button again to adjust the next preference. The preference set order is as follows:

LANGUAGE (English, French, Spanish)  
TIME ZONE (AST, EST, CST, MST, PST, AKST, HAST, NST, AEST, ACST, AWST)  
AUTO DST CHANGE (YES, NO)  
WEATHER TICKER SPEED (SLOW, MEDIUM, FAST)  
CLOCK HOUR  
CLOCK MINUTE  
CALENDAR MONTH\*\*  
CALENDAR DATE\*\*  
CALENDAR YEAR  
TEMPERATURE UNITS (°F or °C)  
WIND SPEED UNITS (MPH, KPH, Knots)  
RAINFALL UNITS (inches or mm)  
PRESSURE UNITS (inHg or hPa)



\*If you live in an area that observes daylight saving time, DST should be set to YES, even if it is not currently Daylight Saving Time.

You will automatically exit SET MODE if no buttons are pressed for 20 seconds. Enter setup mode at any time by pressing the “” button.

## Display Backlight Settings

This weather station’s color display features three different lighting settings: High (100%) brightness, Medium (60%) brightness and Low (15%) brightness.

Using battery power alone, the backlight is available momentarily for 10 seconds by pressing the “” button.

When display is powered with the power adapter, backlight remains on at 100% brightness. Press “” button once to dim to 60% brightness; press again to dim to 15%, press a 3rd time to enter “AUTO DIM” mode. “” icon appears to the left of the time to indicate that auto-dim mode is ON.

<b>AUTO DIM MODE:</b> Automatically adjusts display brightness based on time of day.
6:00 a.m. - 9:00 p.m. = 100% brightness
9:01 p.m. - 5:59 a.m. = 15% brightness

## Placement for Maximum Accuracy

AcuRite sensors are sensitive to surrounding environmental conditions. Proper placement of both the display unit and the sensor are critical to the accuracy and performance of this product.



### Display Unit Placement

Place the display unit in a dry area free of dirt and dust. To ensure accurate temperature measurement, place out of direct sunlight and away from heat sources or vents. Display unit stands upright for tabletop use or is wall-mountable.



### 5-in-1 Sensor Placement

The 5-in-1 sensor is designed to remain outdoors all year long. Choose an open location with no obstructions above or around the sensor for the most accurate measurements.

## Important Placement Guidelines

Display unit and sensor must be within 330 feet (100 meters) of each other.

### MAXIMIZE WIRELESS RANGE

Place units away from large metallic items, thick walls, metal surfaces, or other objects that may limit wireless communication.

### PREVENT WIRELESS INTERFERENCE

Place units at least 3 feet (90 cm) away from electronic devices (TV, computer, microwave, radio, etc.).

### LOCATE AWAY FROM HEAT SOURCES

Position sensor away from heaters, air conditioners, chimneys, exhaust vents, asphalt and concrete (surfaces that radiate heat).

### LOCATE AWAY FROM HUMIDITY SOURCES

Avoid installing the sensor near pools, spas, or other bodies of water. Water sources may impact humidity accuracy.

### LOCATE AWAY FROM SPRINKLER HEADS

DO NOT install the sensor where it will be sprayed by a sprinkler system. This may force water inside the sensor.

### LOCATE AWAY FROM WIND & RAIN OBSTRUCTIONS

DO NOT mount the sensor with obstructions around it. Consider a location that is a wide open area, with few structures around to ensure accurate wind measurement.

Visit us online to view installation photos and video, or learn more about AcuRite technology:

[www.AcuRite.com/5in1](http://www.AcuRite.com/5in1)



View Video

## 5-in-1 Sensor Installation Guidelines

**INSTALLATION HEIGHT** Mount the sensor at a minimum height of 5 feet (1.5 meters) off the ground, in an open area. Higher is better for wind measurements- the National Weather Service recommends 33 feet (10 meters) high!

**MOUNTING OPTIONS** The included mounting bracket is designed to screw directly onto wooden posts or surfaces that are 2" x 4" or larger. The sensor can also be mounted directly to 3/4" steel pipe (available at hardware stores and home centers).

**SOLAR CELL INSTALLATION** Install the sensor with the **solar cell facing SOUTH**. This ensures the cell receives as much sun as possible and orients wind direction.

### 5-in-1 Sensor Installation

1. Fasten mounting base (included) to a post or pole (not included) using the 4 longer screws included in the hardware bag.
2. Insert the mounting base into the hole on the bottom of the sensor.
3. Make sure the arrows on the top of the sensor are pointed in the proper direction and the bubble level is centered. The solar cell should be facing south to properly orient the wind direction.
4. Fasten the sensor into the mounting base using the 2 shorter screws included in the hardware bag.

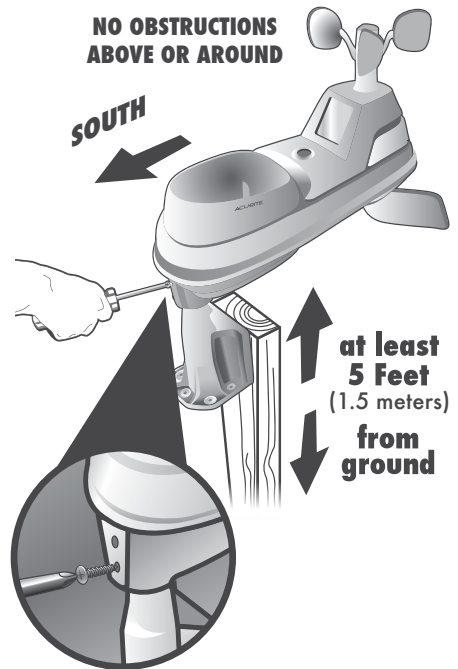

**The 5-in-1 sensor is now ready to use.**

### Clear Data Collected During Installation

When installation is complete, clear erroneous data from the display unit by pressing the "CLEAR RECORD/ RESET" button, on the back of the display inside the battery compartment. This button will clear data recorded since 12:00 am.

### Basic Setup is Complete

The 5-in-1 sensor will now synchronize with the display unit. It may take a few minutes for synchronization to complete. If both or one of the units appear to be functioning improperly, please refer to the troubleshooting section.





## Using the Professional Weather Center

### Learning Mode

Self-Calibrating Forecasting use a unique algorithm to analyze changes in pressure over a time period (called Learning Mode) to determine your altitude. After 14 days, the Learning Mode icon disappears from the display screen. At this point, the self-calibrated pressure is tuned in to your location and the unit is ready for superior weather prediction.

### Weather Forecast

AcuRite's patented Self-Calibrating Forecasting provides your personal forecast of weather conditions for the next 12 to 24 hours by collecting data from the sensor in your backyard. It generates a forecast with pinpoint accuracy - personalized for your exact location.

<p><b>STORMY &amp; WINDY</b></p>  <p>(flashing=stormy)</p>	<p><b>SNOW LIKELY</b></p> 	<p><b>SNOW / RAIN MIX LIKELY</b></p> 	<p><b>RAIN LIKELY</b></p> 	<p><b>CLOUDY</b></p> 
--	---	--	---	--

View the complete list of icons at [www.AcuRite.com/acurite-icons](http://www.AcuRite.com/acurite-icons)

### Weather Select

Weather Select displays data including wind chill, dew point, heat index, 24-hour change in outdoor temperature and humidity, today, month and all-time high and low records for outdoor temperature, outdoor humidity and peak wind speed. To change the "Weather Select" category shown, press the "▲" button on the front of the display.

### Barometric Pressure

Subtle variations in barometric pressure greatly affect the weather. This weather center displays the current pressure with an arrow icon to indicate the direction the pressure is trending (FALLING, STEADY, or RISING).

# Rainfall Tracking

This weather station features enhanced tracking of historical rainfall data. Rain accumulation data is displayed for the current day, week, or month (most recent rainfall total). The rain indicator illustrates today's rain collection up to 1 inch (25 mm).

Press the "☂" button to review historical rainfall records.

Records are shown in the following order:

- CURRENT YEAR TOTAL (default)
- PREVIOUS DAILY TOTALS (up to 3 days prior)
- MONTHLY TOTALS WITH RAIN FOR CURRENT YEAR
- YEARLY TOTALS FOR PREVIOUS YEARS (up to 4 years)
- ALL-TIME TOTAL

## Rainfall Data



### TODAY

Displays rainfall recorded TODAY since 12:00am, if applicable.

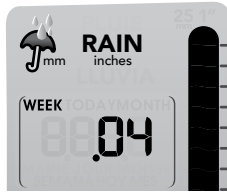

### WEEK

If there hasn't been any rainfall today, the current week's rainfall (Sunday to Saturday) is displayed, if applicable.



### MONTH

If there hasn't been any rainfall this week, the current month's rainfall is displayed.

## Rainfall History

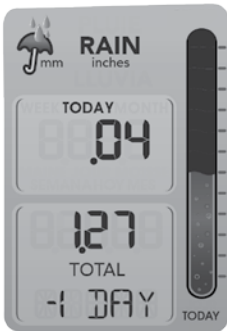

TOTAL RAINFALL FOR PREVIOUS DAY



TOTAL RAINFALL FOR MONTH SHOWN



CURRENT YEAR TOTAL RAINFALL

## **Weather Ticker™**

The Weather Ticker automatically flashes your real-time weather information and alerts as text in the lower part of the display unit screen.

The possible WEATHER TICKER messages are as follows:

HEAT INDEX-XX

WIND CHILL-XX

DEW POINT-XX

IT FEELS LIKE XX OUTSIDE

TODAY'S HIGH HUMIDITY...OUTDOOR XX / INDOOR XX

TODAY'S LOW HUMIDITY...OUTDOOR XX / INDOOR XX

TODAY'S HIGH TEMP...OUTDOOR XX / INDOOR XX

TODAY'S LOW TEMP...OUTDOOR XX / INDOOR XX

7 DAY HIGH TEMP. XX - MM/DD

7 DAY LOW TEMP. XX - MM/DD

30 DAY HIGH TEMP. XX - MM/DD

30 DAY LOW TEMP. XX - MM/DD

ALL TIME HIGH TEMP. XXX...RECORDED MM/DD/YY

ALL TIME LOW TEMP. XXX...RECORDED MM/DD/YY

24 HOUR TEMP. CHANGE +XX

ALL TIME HIGH WIND XX MPH...RECORDED MM/DD/YY

7 DAY AVERAGE WIND XX MPH

TODAY'S AVERAGE WIND XX MPH

MOON - NEW

MOON - WAXING CRESCENT

MOON - FIRST QUARTER

MOON - WAXING GIBBOUS

MOON - FULL

MOON - WANING GIBBOUS

MOON - LAST QUARTER

MOON - WANING CRESCENT

INDOOR HUMIDITY OK

INDOOR HUMIDITY HIGH

INDOOR HUMIDITY LOW

NEW LOW TEMP. RECORD XX

NEW HIGH TEMP. RECORD XX

NEW WIND RECORD TODAY XX

CURRENT RAINFALL X.XX/HR.

RAIN EVENT STARTED XX HRS. AGO

SENSOR BATTERIES LOW

DISPLAY BATTERIES LOW

SENSOR SIGNAL LOST...CHECK BATTERIES AND PLACEMENT

CAUTION- HEAT INDEX IS XXX

CAUTION- WIND CHILL IS XXX

CALIBRATION

DATA LOGGER FULL...CONNECT TO PC TO TRANSFER

# Troubleshooting

Problem	Possible Solution
<p><b>No outdoor sensor reception</b></p>  no bars	<ul style="list-style-type: none"> <li>• Relocate the display unit and/or the 5-in-1 sensor. The units must be within 330 ft (100 m) of each other.</li> <li>• Make sure both units are placed at least 3 feet (90 cm) away from electronics that may interfere with the wireless communication (such as TVs, microwaves, computers, etc).</li> <li>• Use standard alkaline batteries (or lithium batteries in sensor when temperature is below -4°F/-20°C). Do not use heavy duty or rechargeable batteries. NOTE: It may take up to 20 minutes for display unit and sensor to synchronize after batteries are replaced.</li> <li>• Synchronize the units:             <ol style="list-style-type: none"> <li>1. Bring both the sensor and display unit indoors and remove power adapter/batteries from each.</li> <li>2. Reinstall batteries in outdoor sensor.</li> <li>3. Reinstall power adapter/batteries in display unit.</li> <li>4. Let the units sit within a couple feet of each other for about 20 minutes to gain a strong connection.</li> </ol> </li> </ul>
<p><b>Outdoor temperature is flashing or showing dashes</b></p>	<p>Flashing of the outdoor temperature may be an indication of wireless interference.</p> <ul style="list-style-type: none"> <li>• Make sure the A-B-C switch in the battery compartments of both the display unit and sensor are switched to the same letter. You may choose A, B or C; but both units must match to sync up. Sometimes changing to a different channel can help.</li> </ul>
<p><b>Inaccurate forecast</b></p>	<ul style="list-style-type: none"> <li>• Weather Forecast icon predicts conditions for the next 12 to 24 hours, not current conditions.</li> <li>• Has Learning Mode icon disappeared from the display unit? Learning Mode must complete before forecast and pressure will be accurate.</li> <li>• Allow unit to run continuously for 33 days. Battery removal or resetting the display unit will restart Learning Mode. After 14 days, forecast should be fairly accurate, however Learning Mode calibrates for a total of 33 days.</li> </ul>



# Troubleshooting

<b>Problem</b>	<b>Possible Solution</b>
<b>Inaccurate temperature or humidity</b>	<ul style="list-style-type: none"><li>• Make sure both the display unit and 5-in-1 sensor are placed away from any heat sources or vents (see page 11).</li><li>• Make sure both units are positioned away from moisture sources (see page 11).</li><li>• Make sure 5-in-1 sensor is mounted at least 5 ft off of the ground.</li><li>• Calibrate indoor and outdoor temperature and humidity (see page 19).</li></ul>
<b>No rainfall</b>	<ul style="list-style-type: none"><li>• Check to ensure the rain gauge stabilizer (plastic tab) has been removed from the bottom of the sensor (see page 7).</li><li>• Clear debris, such as leaves, out of the rain collector funnel and debris screen.</li><li>• Calibrate the Rain Gauge (see page 20).</li></ul>
<b>Inaccurate wind readings</b>	<ul style="list-style-type: none"><li>• What is wind reading being compared to? Pro weather stations are typically mounted at 30 ft high or more. Make sure to compare data using a sensor positioned at the same mounting height.</li><li>• Check location of the sensor. Ensure it's mounted a minimum of 5 ft in the air with no obstructions around it (within several feet).</li><li>• Ensure wind cups are spinning freely. If they hesitate or stop try lubricating with graphite powder or spray lubricant.</li></ul>
<b>Display screen not working</b>	<ul style="list-style-type: none"><li>• Check that the batteries are installed correctly. Batteries may need to be replaced.</li><li>• Reset the display by pressing and holding the CLEAR RECORD / RESET button, located in the battery compartment of the display unit. Date and time will need to be entered after a reset.</li></ul>

# Troubleshooting

Problem	Possible Solution
<b>Cannot access data online or on the AcuRite mobile app</b>	<ul style="list-style-type: none"><li>• Verify that the status in the AcuRite Connect software on your PC indicates that data was uploaded OK.</li><li>• Verify that you created an account or logged into an existing account at <a href="http://www.acu-link.com">www.acu-link.com</a> or in the AcuRite app, and that you input the display's MAC ADDRESS as a part of the account setup.</li><li>• Verify that the USB cable is securely connected to the display AND to the PC.</li><li>• Verify the display is powered ON.</li><li>• Verify the PC that the display is connected to is always powered ON.</li><li>• Verify the PC that the display is connected to is always connected to the internet.</li><li>• Verify that the display's MAC ADDRESS is entered correctly in the AcuRite Connect software on your PC.</li><li>• Verify that "Streaming" is enabled in the AcuRite Connect software on your PC.</li><li>• Verify that the display's MAC ADDRESS is correct in your <a href="http://www.acu-link.com">www.acu-link.com</a> and/or AcuRite mobile app account.</li><li>• Follow on-screen troubleshooting steps in the AcuRite Connect software.</li></ul>
<b>AcuRite Connect data is different than the display's data</b>	<ul style="list-style-type: none"><li>• Check that the USB cable is securely connected to the display AND to the PC's USB port.</li><li>• Restart the AcuRite Connect software.</li><li>• Unplug the USB cable from the PC for 1 minute, and then plug the cable back in again.</li><li>• USB port may be malfunctioning, try using another USB port.</li></ul>

**If your AcuRite product does not operate properly after trying the troubleshooting steps, visit [www.AcuRite.com](http://www.AcuRite.com) or call (877) 221-1252 for assistance.**

# Care & Maintenance

## Display Unit Care

Clean with a soft, damp cloth. Do not use caustic cleaners or abrasives. Keep away from dust, dirt and moisture. Clean ventilation ports regularly with a gentle puff of air.

## 5-in-1 Sensor Care

### Clean the Sensor

Clean with a soft damp cloth. Do not use caustic cleaners or abrasives that will mar the polished surfaces of the rain collection funnel or the solar cell. Scratches will result in decreased performance and reliability.

### Insect Prevention

Insects may cause obstructions and interrupt data by nesting in or on the 5-in-1 sensor. To limit this problem, spray sensor with a household insect repellent. Consult the insect repellent instructions prior to use.

### Snow & Freezing Weather

The 5-in-1 sensor will not be damaged by freezing conditions. NOTE: If the rain collector cup fills with snow and then melts, it will register as rain on the display unit.

### Clean the Rain Collector Cup

Remove and empty rain collector debris filter. The debris filter is located in the rain collector funnel. Remove from the top by gently squeezing and pulling out.

### Clean the Wind Vane & Anemometer

Remove foreign matter from the outside of the sensor for free movement of the wind vane and anemometer. If needed, use a small amount of spray lubricant, clear silicone or graphite powder on the anemometer for improved movement.

## Calibration

The indoor and outdoor temperature and humidity readings, and barometric pressure can be calibrated on the display unit to improve accuracy. Calibration can improve accuracy when sensor placement or environmental factors impact the data accuracy.

1. To access calibration mode, press AND HOLD the " + ", " ⚙️ ", and " - " buttons simultaneously for at least 5 seconds.
2. To adjust the currently selected (flashing) item, press and release the " + " or " - " buttons to calibrate the data value higher or lower from the actual reading.
3. To save your adjustments, press and release the " ⚙️ " button to adjust the next preference. The " ⚙️ " icon will remain illuminated next to calibrated values.

The preference set order is as follows:  
OUTDOOR TEMPERATURE  
OUTDOOR HUMIDITY

## INDOOR TEMPERATURE

## INDOOR HUMIDITY

## BAROMETRIC PRESSURE (must be set to MANUAL mode to calibrate)\*

\*To change from AUTO to MANUAL pressure mode and vice versa, press AND HOLD the “⚙️” button for 5-7 seconds. The display indicates the current pressure mode selected, “AUTO” or “MANUAL”. The “⚡” icon will appear next to the barometric pressure to indicate that MANUAL mode has been activated. Press and HOLD the “⚙️” button for 5-7 seconds to return to AUTO mode.

After 5-10 seconds of inactivity, the display will save the adjustments and exit calibration mode. Note: Calibrations will be erased if the display is reset or if batteries are removed and the power adapter is unplugged.

## Calibrate the Rain Gauge

The rain gauge on the 5-in-1 sensor can be calibrated to improve accuracy.

**Items Needed:** 5-in-1 sensor, display unit, plastic cup, pin, screw driver

1. First, ensure 5-in-1 sensor is perfectly level using built-in bubble level.
2. Place display unit close so you can monitor it during calibration.
3. Make a pin hole in the bottom of a plastic cup. Hold the cup over the rain gauge and fill it with exactly 1 cup (8oz) of water, allowing the water to drip into the rain gauge. You should hear the internal buckets tip and see water drain through the rain gauge.
4. A few seconds after each bucket tip, the display unit displays rainfall in approximately 0.01” or more increments.
5. The cup of water should take more than 20 minutes to empty; a quicker period will result in inaccurate calibration. Try to simulate a normal steady rainfall. When cup is empty of water, display unit should register 1.06”

## Tips

- There should be nearly an equal number of water drops (about 25 water drops) between bucket tips. If not, adjust the calibration screws on the bottom of the 5-in-1 sensor until an equal number of water drops are tipping the buckets. Then, restart the calibration procedure.
- If you don't hear the buckets tipping and see water dripping alternately out of each drain, there may be an issue with the rain gauge or it's adjustment. See Troubleshooting on page 18.

## Adjustment

If the rain gauge doesn't register close to 1.06”, make an EQUAL adjustment to the two calibration screws on the bottom of the 5-in-1 sensor. Turning screws clockwise increases rainfall; counter clockwise decreases rainfall.

- To adjust the rainfall reading by 2% turn both screws 1/8 of a turn.
- To adjust the rainfall reading by 4% turn both screws 1/4 of a turn.
- To adjust the rainfall reading by 8% turn both screws 1/2 of a turn.

Watch the video at [www.acurite.com/5in1](http://www.acurite.com/5in1)

# Specifications

<b>TEMPERATURE RANGE</b>	Outdoor: -40°F to 158°F; -40°C to 70°C
	Indoor: 32°F to 122°F; 0°C to 50°C
<b>HUMIDITY RANGE</b>	Outdoor: 1% to 99%
	Indoor: 1% to 99%
<b>WIND SPEED</b>	0 to 99 mph; 0 to 159 kph
<b>WIND DIRECTION INDICATORS</b>	16 points
<b>RAINFALL</b>	0 to 3937 in; 0 to 99999mm
<b>WIRELESS RANGE</b>	330ft / 100m depending on home construction materials
<b>OPERATING FREQUENCY</b>	433 MHz
<b>POWER</b>	Display: 4.5V AC, 250mA adapter 3 x AA alkaline batteries (optional)
	Sensor: 4 x AA alkaline or lithium batteries
<b>DATA REPORTING</b>	Wind Speed: 18 second updates; Direction: 30 seconds Outdoor temperature & humidity: 36 second updates Indoor temperature & humidity: 60 second updates AcuRite Connect CSV Data Logging: 12 minute intervals AcuRite Connect to AcuRite Software/App: 18 seconds
<b>DISPLAY UNIT MEMORY</b>	512 kilobytes (not expandable)
<b>ACURITE CONNECT SYSTEM REQUIREMENTS</b>	Windows 8.1 / 8 / 7; 1 GHz or faster processor; 1 GB (32-bit) or 2 GB (64-bit) of RAM; available USB port
	High speed internet is required for some advanced features of AcuRite Connect, such as the AcuRite software and app.

# FCC Information

This device complies with part 15 of FCC rules. Operation is subject to the following two conditions:

- 1- This device may NOT cause harmful interference, and
  - 2- This device must accept any interference received, including interference that may cause undesired operation.
- This equipment has been tested and found to comply with the limits for a Class B digital device, pursuant to Part 15 of the FCC rules. These limits are designed to provide reasonable protection against harmful interference in a residential installation. This equipment generates, uses and can radiate radio frequency energy and, if not installed and used in accordance with the instructions, may cause harmful interference to radio communications. However, there is no guarantee that interference will not occur in a particular installation. If this equipment does cause harmful interference to radio or television reception, which can be determined by turning the equipment off and on, the user is encouraged to try to correct the interference by one or more of the following measures:

- Reorient or relocate the receiving antenna.
- Increase the separation between the equipment and the receiver.
- Connect the equipment into an outlet on a circuit different from that to which the receiver is connected.
- Consult the dealer or an experienced radio/TV technician for help.

NOTE: The manufacturer is not responsible for any radio or TV interference caused by unauthorized modifications to this equipment. Such modifications could void the user authority to operate the equipment.

This device complies with Industry Canada licence-exempt RSS standard(s).

Operation is subject to the following two conditions:

- (1) This device may not cause interference, and
- (2) This device must accept any interference received, including interference that may cause undesired operation of the device.

## Customer Support

AcuRite customer support is committed to providing you with best-in-class service. **For assistance**, please have the model number of this product available and contact us in any of the following ways:



(877) 221-1252



info@chaney-inst.com

24/7 support at [www.AcuRite.com](http://www.AcuRite.com)

- ▶ Installation Videos
- ▶ Register your Product
- ▶ Instruction Manuals
- ▶ Support User Forum
- ▶ Replacement Parts
- ▶ Submit Feedback & Ideas

## IMPORTANT

PRODUCT MUST BE REGISTERED  
TO RECEIVE WARRANTY SERVICE

### PRODUCT REGISTRATION

Register online  
to receive 1 year  
warranty protection

[www.AcuRite.com](http://www.AcuRite.com)

FOR NOW

SUPPORT

Support Forum

Archived Products

▶ Register a Product

## Limited One Year Warranty

At AcuRite, we proudly uphold our commitment to quality technology. Chaney Instrument Co. warrants that all products it manufactures to be of good material and workmanship, and to be free of defects when properly installed and operated for a period of one year from the date of purchase.

We recommend that you visit us at [www.AcuRite.com](http://www.AcuRite.com) for the fastest way to register your product. However, product registration does not eliminate the need to retain your original proof of purchase in order to obtain warranty benefits.

Chaney Instrument Co. warrants that all products it manufactures to be of good material and workmanship, and to be free of defects when properly installed and operated for a period of one year from the date of purchase. Remedy for breach of this warranty is limited to repair or replacement of the defective item(s). Any product which, under normal use and service, is proven to breach the warranty contained herein within ONE YEAR from date of sale will, upon examination by Chaney, and at its sole option, be repaired or replaced by Chaney. Transportation costs and charges for returned goods shall be paid for by the purchaser. Chaney hereby disclaims all responsibility for such transportation costs and charges. This warranty will

not be breached, and Chaney will give no credit for products it manufactures which have received normal wear and tear, been damaged (including by acts of nature), tampered, abused, improperly installed, damaged in shipping, or repaired or altered by others than authorized representatives of Chaney.

The above-described warranty is expressly in lieu of all other warranties, express or implied, and all other warranties are hereby expressly disclaimed, including without limitation the implied warranty of merchantability and the implied warranty of fitness for a particular purpose. Chaney expressly disclaims all liability for special, consequential or incidental damages, whether arising in tort or by contract from any breach of this warranty. Some states do not allow the exclusion or limitation of incidental or consequential damages, so the above limitation or exclusion may not apply to you. Chaney further disclaims all liability from personal injury relating to its products to the extent permitted by law. By acceptance of any of Chaney's products, the purchaser assumes all liability for the consequences arising from their use or misuse. No person, firm or corporation is authorized to assume for Chaney any other liability in connection with the sale of its products. Furthermore, no person, firm or corporation is authorized to modify or waive the terms of this paragraph, and the preceding paragraph, unless done in writing and signed by a duly authorized agent of Chaney. This warranty gives you specific legal rights, and you may also have other rights which vary from state to state.

For in-warranty claims:

Chaney Instrument Co. | 965 Wells St. | Lake Geneva, WI 53147



# ACU>RITE®



Weather  
Stations



Temperature  
& Humidity



Weather  
Alert Radio



Kitchen  
Thermometers  
& Timers



Clocks

*It's More than Accurate, it's ACU>RITE.*

AcuRite offers an extensive assortment of precision instruments, designed to provide you with information you can depend on to Plan your day with confidence™.

[www.AcuRite.com](http://www.AcuRite.com)

©Chaney Instrument Co. All rights reserved. AcuRite is a registered trademark of the Chaney Instrument Co., Lake Geneva, WI 53147. All other trademarks and copyrights are the property of their respective owners. AcuRite uses patented technology. Visit [www.AcuRite.com/patents](http://www.AcuRite.com/patents) for details.