

Weather Station model 02407SBL



CONTENTS

Unpacking Instructions	2	Placement Guidelines	9
Package Contents	2	Using the Weather Station	10
Product Registration	2	Programmable Alarms	11
Features and Benefits: Sensor ...	2	Troubleshooting	12
Features and Benefits: Display ...	3	Care and Maintenance	13
Setup	6	Calibration	13
Sensor Setup	6	Specifications	14
Display Setup	7	FCC Information	14
Set the Time, Date and Units	8	Customer Support	15
Backlight Settings	8	Warranty	15

Questions? Contact Customer Support at www.AcuRite.com/support or email support@chaney-inst.com

SAVE THIS MANUAL FOR FUTURE REFERENCE.

ACURITE®

Congratulations on your new AcuRite product. To ensure the best possible product performance, please read this manual in its entirety and retain it for future reference.

Unpacking Instructions

Remove the protective film that is applied to the LCD screen prior to using this product. Locate the tab and peel off to remove.

Package Contents

1. Display
2. Outdoor Sensor
3. Power Adapter
4. Instruction Manual

IMPORTANT

PRODUCT MUST BE REGISTERED
TO RECEIVE WARRANTY SERVICE

PRODUCT REGISTRATION

Register online to receive 1 year of warranty protection

www.AcuRite.com

Features and Benefits



OUTDOOR SENSOR

- 1. Integrated Hanger**
For easy placement.
- 2. Wireless Signal Indicator**
Flashes when data is being sent to the display.
- 3. Battery Compartment**
- 4. A-B-C Switch**
ID code that must match display's A-B-C switch to ensure units synchronize.
- 5. Battery Compartment Cover**

Features and Benefits

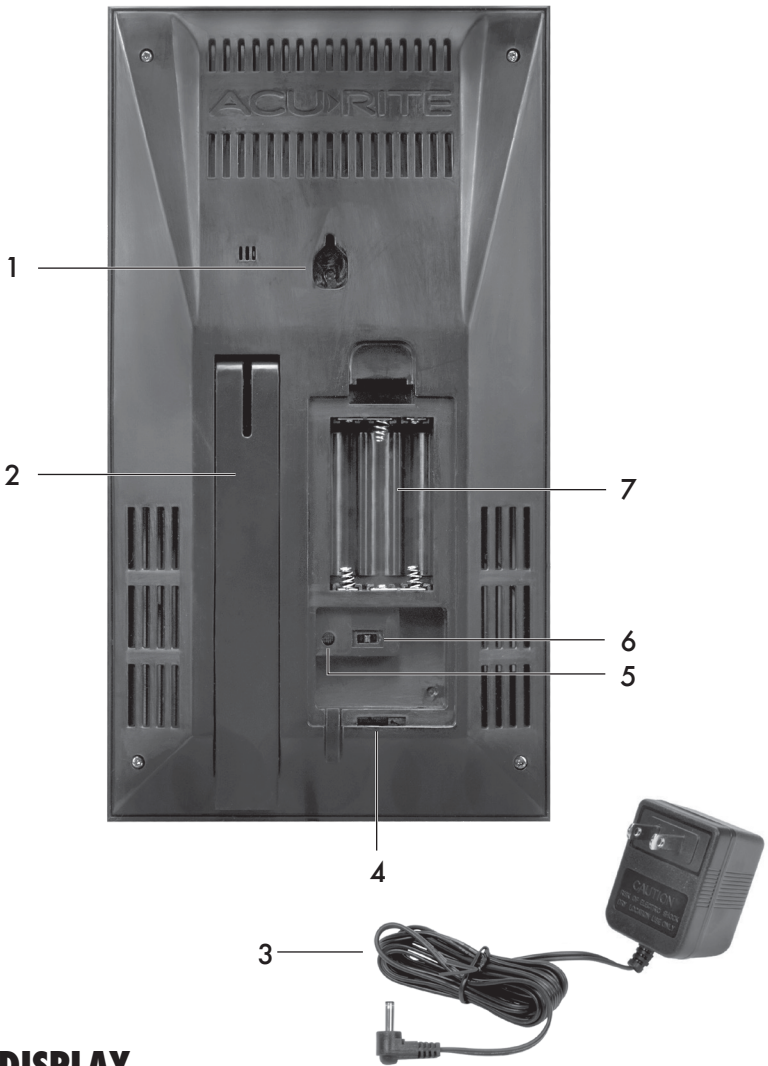







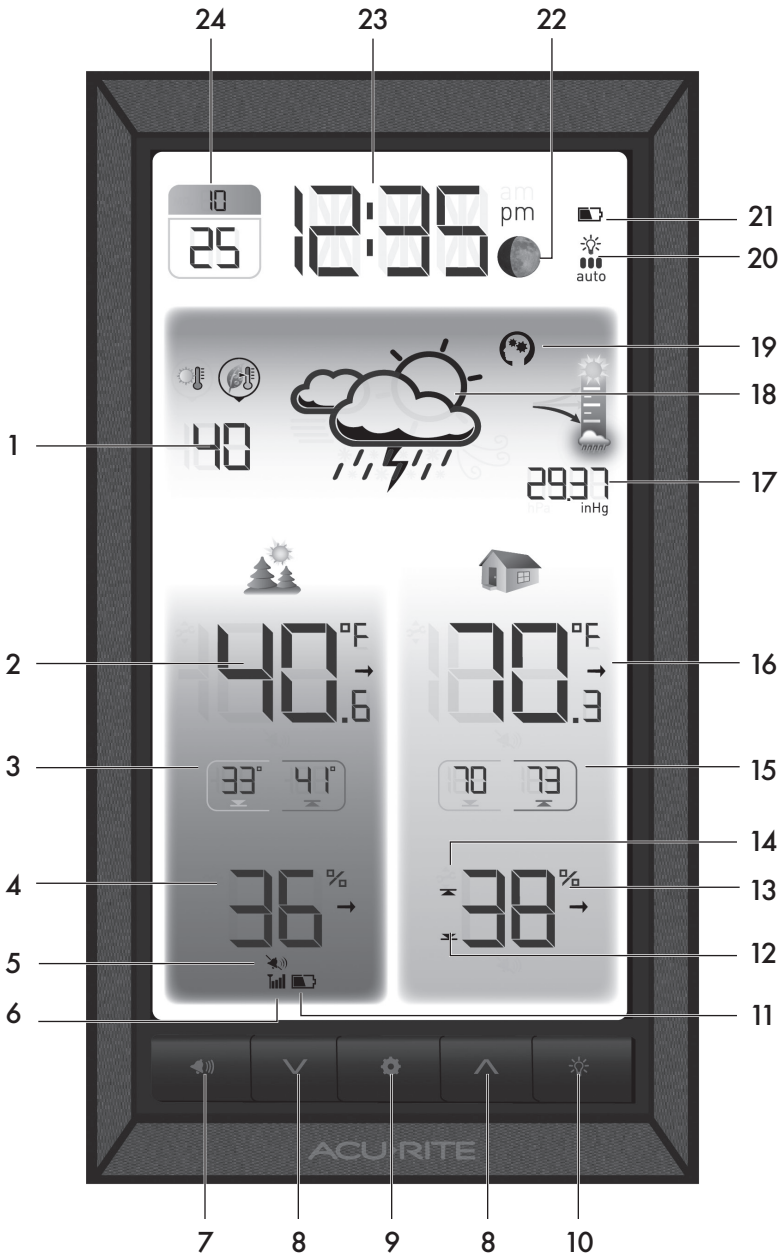

BACK OF DISPLAY

- 1. Integrated Hang Hole**
For easy wall mounting.
- 2. Fold-out Tabletop Stand**
- 3. Power Adapter**
- 4. Plug-in for Power Adapter**
- 5. RESET Button**
For full reset to factory defaults.
- 6. A-B-C Switch**
ID code that must match sensor's A-B-C switch to ensure units synchronize.
- 7. Backup Battery Compartment**
- 8. Battery Compartment Cover**
(not shown)

Features and Benefits



1. **Heat Index/Dew Point**
Heat Index calculation displays when temperature is 80°F (27°C) or above.
Dew Point calculation displays when temperature is 79°F (26°C) or below.
2. **Current Outdoor Temperature**
Arrow icon indicates the direction temperature is trending.
3. **Outdoor High & Low Temperature Records**
Highest and lowest temperature recorded since midnight.
4. **Current Outdoor Humidity**
Arrow icon indicates the direction humidity is trending.
5.  **Alarm ON Indicator**
Indicates alarm is activated to emit an audible alert when conditions exceed your presets (see page 11).
6. **Outdoor Sensor Signal Strength**
7.  **Button**
For alarm setup.
8.  **Buttons**
For setup preferences and viewing indoor high & low records.
9.  **Button**
For setup preferences.
10.  **Button**
For momentary backlight and dimmer settings.
11. **Sensor Low Battery Indicator**
12.  **Icon**
Indicates low records are being viewed.
13. **Current Indoor Humidity**
Arrow icon indicates direction humidity is trending.
14.  **Icon**
Indicates high records are being viewed.
15. **Indoor High & Low Temperature Records**
Highest and lowest temperature recorded since midnight.
16. **Current Indoor Temperature**
Arrow icon indicates direction temperature is trending.
17. **Current Barometric Pressure**
Arrow icon indicates the direction pressure is trending.
18. **12 to 24 Hour Weather Forecast**
Self-calibrating forecasting pulls data from the outdoor sensor to generate your personal forecast.
19.  **Icon**
Disappears after weather forecast self-calibration is complete (see page 10).
20.  **Icon**
Indicates display is in auto-dimming brightness mode (see page 8).
21. **Display Low Battery Indicator**
22. **Moon Phase**
23. **Clock**
24. **Date**

Sensor Setup

1 Set the A-B-C Switch

The A-B-C switch is located inside the battery compartment. It can be set to A, B or C. However, you must select the same letter choices for both the sensor and the display in order for the units to synchronize.

2 Install or Replace Batteries

AcuRite recommends high quality alkaline batteries in the outdoor sensor for the best product performance. Heavy duty or rechargeable batteries are not recommended.

1. Slide off the battery compartment cover. Take note of the A-B-C switch setting inside the battery compartment for display setup.
2. Insert 2 x AA batteries into the battery compartment, as shown. Follow the polarity (+/-) diagram in the battery compartment.
3. Replace the battery cover.



LITHIUM BATTERIES **-40°F** (-40°C) (70°C) **158°F**

ALKALINE BATTERIES **-4°F** (-20°C) (70°C) **158°F**

Display Setup

1 Set the A-B-C Switch

Locate the A-B-C switch inside the battery compartment. Set the A-B-C switch to A, B or C. You must select the same letter choices for both the display and the sensor in order for the units to synchronize.

2 Install or Replace Backup Batteries (optional)

1. Remove the battery compartment cover.

2. Insert 3 x AAA alkaline batteries into the battery compartment, as shown. Follow the polarity (+/-) diagram in the battery compartment.

3. Replace the battery cover.

3 Plug in Power Adapter

For the best performance, plug in the power adapter as the main power source for this product.

1 A-B-C Switch Set to match sensor

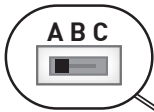

2 Install Backup Batteries 3 AAA Batteries (optional)



3 Plug in Power Adapter

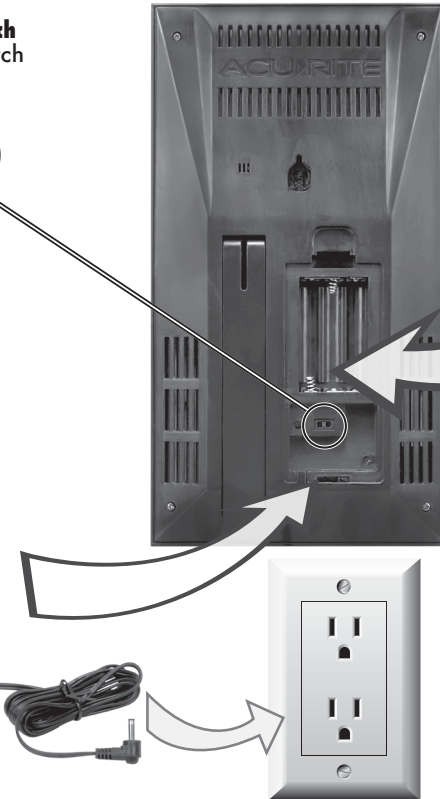

IMPORTANT: Batteries are a backup power source to preserve records in the event of a power outage. **Power adapter is recommended as the primary power source to enjoy the full functionality of this product.**





PLEASE DISPOSE OF OLD OR DEFECTIVE BATTERIES IN AN ENVIRONMENTALLY SAFE WAY AND IN ACCORDANCE WITH YOUR LOCAL LAWS AND REGULATIONS.

BATTERY SAFETY: Clean the battery contacts and also those of the device prior to battery installation. Remove batteries from equipment that will not be used for an extended period of time. Follow the polarity (+/-) diagram in the battery compartment. Promptly remove dead batteries from the device. Dispose of used batteries properly. Only batteries of the same or equivalent type as recommended are to be used. DO NOT incinerate used batteries. DO NOT dispose of batteries in fire, as batteries may explode or leak. DO NOT mix old and new batteries or types of batteries (alkaline/standard). DO NOT use rechargeable batteries. DO NOT recharge non-rechargeable batteries. DO NOT short-circuit the supply terminals.

Set the Time, Date and Units

Press and release the “” button, located on the front of the display, to enter SET MODE. Once in set mode, the preference you are currently setting will blink on the display.

To adjust the currently selected (flashing) item, press and release the “” or “” buttons (press and HOLD to fast adjust).

To save your adjustments, press and release the “” button again to adjust the next preference. The preference set order is as follows:

Auto DST (Daylight Saving Time  ON of OFF)*

CLOCK HOUR

CLOCK MINUTE

CALENDAR MONTH

CALENDAR DATE

CALENDAR YEAR

TEMPERATURE UNITS (°C or °F)

PRESSURE UNITS (hPa or inHg)

*If you live in an area that observes DST, DST should be set to ON, even if it is not currently Daylight Saving Time.

You will automatically exit SET MODE if no buttons are pressed for 10 seconds. Enter setup mode at any time by pressing the “” button.

Display Backlight Settings

This weather station's color display features three different lighting settings: High (100%) brightness, Medium (50%) brightness and Low (15%) brightness.

Using battery power alone, the backlight is available momentarily for 10 seconds by pressing the Backlight button.

When display is powered with the power adapter, backlight remains on at 100% brightness. Press Backlight button once to dim to 50% brightness; press again to dim to 15%, press a 3rd time to enter AUTO DIM mode.

NOTE: Pressing and holding the “” button for 5 seconds will disable the backlight. Once any button is pressed, the backlight will return to your selected setting.

AUTO DIM MODE: Automatically adjusts display brightness based on time of day.
6:00 a.m. - 9:00 p.m. = 100% brightness
9:01 p.m. - 5:59 a.m. = 15% brightness

Placement for Maximum Accuracy

AcuRite sensors are sensitive to surrounding environmental conditions. Proper placement of both the display and outdoor sensor are critical to the accuracy and performance of this product.



Display Placement

Place the display in a dry area free of dirt and dust. Display stands upright for tabletop use and is wall-mountable.

Outdoor Sensor Placement

Sensor must be placed outside to observe outdoor conditions. Sensor is water resistant and is designed for general outdoor use, however, to extend its life place the sensor in an area protected from direct weather elements.

Hang the sensor using the integrated hang hole or hanger, or by using string (not included) to hang it from a suitable location, like a well covered tree branch. The best location is 4 to 8 feet (1 to 2 meters) above the ground with permanent shade and plenty of fresh air to circulate around the sensor.

Important Placement Guidelines

- To ensure accurate temperature measurement, place units out of direct sunlight and away from any heat sources or vents.
- Display and outdoor sensor must be within 330 ft (100 m) of each other.
- To maximize wireless range, place units away from large metallic items, thick walls, metal surfaces, or other objects that may limit wireless communication.
- To prevent wireless interference, place both units at least 3 ft (90 cm) away from electronic devices (TV, computer, microwave, radio, etc.).

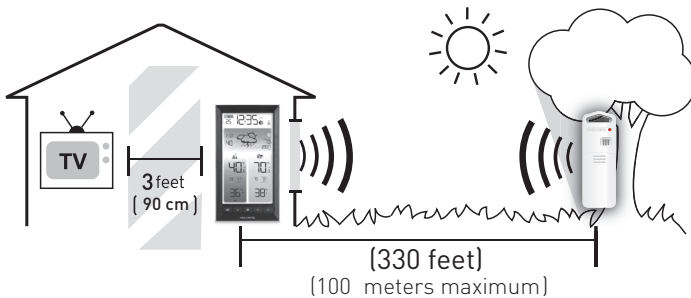





Setup is Complete

The sensor will now synchronize with the display. It may take a few minutes for synchronization to complete. Please refer to the troubleshooting section of this manual if anything appears to be functioning improperly.

Using the Weather Station

Weather Forecast

Self-calibrating forecasting uses a unique algorithm to analyze changes in pressure over a time period (called Learning Mode) to determine your altitude. After 14 days, the ☼ icon disappears from the display screen. At this point, the self-calibrated pressure is tuned in to your location and the unit is ready for superior weather prediction.

<p>STORMY & WINDY</p>  <p>(flashing=stormy)</p>	<p>SNOW LIKELY</p> 	<p>SNOW / RAIN MIX LIKELY</p> 	<p>CHANCE OF RAIN</p> 	<p>CLOUDY</p> 
--	---	--	--	--

Moon Phase

Track the phases of the moon, conveyed through simple lunar phase icons:



Barometric Pressure

Subtle variations in barometric pressure greatly affect the weather. This weather station displays the current pressure with an arrow icon to indicate the direction the pressure is trending (FALLING, STEADY, or RISING).

High and Low Records

High and low records for today and all-time are displayed for indoor and outdoor temperature and humidity. Today's records automatically clear at 12:00am midnight every day.













Press the "∧" and "∨" buttons to cycle through high and low recorded values for outdoor and indoor temperature and humidity. While viewing all-time records, a date and timestamp are shown for when each value was recorded. You will automatically exit records if no buttons are pressed for 8 seconds.

To manually clear a HIGH or LOW record, press and HOLD both the "∧" and "∨" buttons simultaneously for 3 seconds while viewing the record(s) you wish to clear. Dashes display to confirm you have cleared the record(s).







Programmable Alarms

This display features programmable alarms that sound an alert to notify you when a value (for temperature or humidity) has been reached or exceeded. When an alarm is triggered, the display emits an audible beep and flashes data in the affected category. You can customize the alarms by turning ON or OFF the alarms you'd like activated or deactivated, and by inputting your own values to trigger the alarm.

Setup an Alarm

1. Press and release the ")" button until the reading for which you wish to set an alarm is shown on the display. "" will be shown.
2. Press and release the "" or "" buttons until ")" appears.
3. Press and release the "" button. The current HIGH alarm value will be shown.
3. Press and release the "" or "" buttons to adjust the alarm's HIGH value.
4. Press and release the "" button. The current LOW alarm value will be shown.
5. Press and release the "" or "" buttons to adjust the alarm's LOW value.
6. Press and release the "" button to end alarm adjustments, OR press and release the ")" button to cycle to the next reading.

Disable an Alarm

1. Press and release the ")" button until the reading for which you wish to disable an alarm is shown on the display. ")" will be shown.
2. Press and release the "" or "" buttons until "" appears.
3. Press and release the ")" button to cycle to the next reading.
4. Repeat steps 1-3, as needed.

NOTE: To disable ALL alarms at once, press and HOLD the ")" button for 10 seconds.

You will automatically exit alarm SET MODE if no buttons are pressed for 10 seconds. Enter alarm SET MODE at any time by pressing the ")" button.

Troubleshooting

Problem	Possible Solution
<p>No outdoor sensor reception</p>  no bars	<p>If the wireless signal indicator shows no bars:</p> <ul style="list-style-type: none"> • Relocate the display and/or the outdoor sensor. The units must be within 330 ft (100 m) of each other. • Make sure both units are placed at least 3 feet (.9 m) away from electronics that may interfere with the wireless communication (such as TVs, microwaves, computers, etc.). • Use standard alkaline batteries (or lithium batteries in sensor when temperature is below -4°F/ -20°C). Do not use heavy-duty or rechargeable batteries. NOTE: It may take a few minutes for display and sensor to synchronize after batteries are replaced.
<p>Outdoor temperature is flashing or showing dashes</p>	<p>Flashing of the outdoor temperature is generally an indication of wireless interference.</p> <ol style="list-style-type: none"> 1. Bring both the sensor and display indoors and remove batteries from each. 2. Make sure the A-B-C switches on both units match. 3. Reinstall batteries in the outdoor sensor. 4. Reinstall batteries in the display. 5. Let the units sit within a couple feet of each other for a few minutes to gain a strong connection.
<p>Inaccurate forecast</p>	<ul style="list-style-type: none"> • Weather Forecast icon predicts conditions for the next 12 to 24 hours, not current conditions. • Has the learning mode icon disappeared from the display? Learning Mode must complete before forecast and pressure will be accurate. • Allow unit to run continuously for 33 days. Battery removal or resetting the display will restart Learning Mode. After 14 days, forecast should be fairly accurate, however, Learning Mode calibrates for a total of 33 days.
<p>Inaccurate temperature or humidity</p>	<ul style="list-style-type: none"> • Make sure both the display and sensor are placed out of direct sunlight and away from any heat sources or vents (see page 9). • Make sure both units are positioned away from moisture sources (see page 9).
<p>Display screen not working</p>	<ul style="list-style-type: none"> • Check that the power adapter is plugged into the display and an electrical outlet. • Reset the display by pressing the reset button, located on the back of the display. Date and time will need to be entered after a reset
<p>If your AcuRite product does not operate properly after trying the troubleshooting steps, visit www.AcuRite.com/support or email support@chaney-inst.com.</p>	

Care and Maintenance

Display Care

Clean with a soft, damp cloth. Do not use caustic cleaners or abrasives. Keep away from dust, dirt and moisture. Clean ventilation ports regularly with a gentle puff of air.

Outdoor Sensor Care

Clean with a soft damp cloth. Do not use caustic cleaners or abrasives.

Calibration

The indoor / outdoor temperature and humidity readings, and barometric pressure can be calibrated on the display to improve accuracy. Calibration can improve accuracy when sensor placement or environmental factors impact the data accuracy.

1. To access calibration mode, press AND HOLD the “^”, “⚙️”, and “v” buttons simultaneously for at least 5 seconds.
2. To adjust the currently selected (flashing) item, press and release the “^” or “v” buttons to calibrate the data value higher or lower from the actual reading.
3. To save your adjustments, press and release the “⚙️” button to adjust the next preference. The “🔌” icon will remain illuminated next to calibrated values.

The preference set order is as follows:

OUTDOOR TEMPERATURE

OUTDOOR HUMIDITY

INDOOR TEMPERATURE

INDOOR HUMIDITY

BAROMETRIC PRESSURE (must be set to MANUAL mode to calibrate)*

*To change from AUTO to MANUAL pressure mode and vice versa, press AND HOLD the “⚙️” button for 10 seconds. “manual” will appear below the barometric pressure to indicate that MANUAL mode has been activated. Press and HOLD the “⚙️” button for 10 seconds to return to AUTO mode.

After 20 seconds of inactivity, the display will save the adjustments and exit calibration mode. Note: Calibrations will be erased if the display is reset or if batteries are removed and the power adapter is unplugged.

Specifications

TEMPERATURE RANGE	Outdoor: -40°F to 158°F; -40°C to 70°C
	Indoor: 32°F to 122°F; 0°C to 50°C
HUMIDITY RANGE	Outdoor: 1% to 99% RH
	Indoor: 1% to 99% RH
WIRELESS RANGE	330 ft / 100 m depending on home construction materials
OPERATING FREQUENCY	433 MHz
POWER	Display: 5V, 250mA power adapter 3 x AAA alkaline batteries (optional)
	Sensor: 2 x AA alkaline or lithium batteries
DATA REPORTING	Outdoor: 16 second updates
	Indoor: 60 second updates

FCC Information

This device complies with part 15 of FCC rules. Operation is subject to the following two conditions:

- 1- This device may NOT cause harmful interference, and
- 2- This device must accept any interference received, including interference that may cause undesired operation.

WARNING: Changes or modifications to this unit not expressly approved by the party responsible for compliance could void the user's authority to operate the equipment.

NOTE: This equipment has been tested and found to comply with the limits for a Class B digital device, pursuant to Part 15 of the FCC rules. These limits are designed to provide reasonable protection against harmful interference in a residential installation. This equipment generates, uses and can radiate radio frequency energy and, if not installed and used in accordance with the instructions, may cause harmful interference to radio communications. However, there is no guarantee that interference will not occur in a particular installation. If this equipment does cause harmful interference to radio or television reception, which can be determined by turning the equipment off and on, the user is encouraged to try to correct the interference by one or more of the following measures:

- Reorient or relocate the receiving antenna.
 - Increase the separation between the equipment and the receiver.
 - Connect the equipment into an outlet on a circuit different from that to which the receiver is connected.
 - Consult the dealer or an experienced radio/TV technician for help.
- NOTE:** The manufacturer is not responsible for any radio or TV interference caused by unauthorized modifications to this equipment. Such modifications could void the user authority to operate the equipment.

This device complies with Industry Canada licence-exempt RSS standard(s).

Operation is subject to the following two conditions:

- (1) This device may not cause interference, and
- (2) This device must accept any interference received, including interference that may cause undesired operation of the device.

Customer Support

AcuRite customer support is committed to providing you with best-in-class service. **For assistance**, please have the model number of this product available and contact us in any of the following ways:



support@chaney-inst.com

Visit us at www.AcuRite.com

- ▶ Installation Videos
- ▶ Register your Product
- ▶ Instruction Manuals
- ▶ Support User Forum
- ▶ Replacement Parts
- ▶ Submit Feedback & Ideas

IMPORTANT

PRODUCT MUST BE REGISTERED
TO RECEIVE WARRANTY SERVICE

PRODUCT REGISTRATION

Register online to receive 1 year warranty protection

www.AcuRite.com

Limited 1-Year Warranty

AcuRite is a wholly owned subsidiary of Chaney Instrument Company. For purchases of AcuRite products, AcuRite provides the benefits and services set forth herein. For purchases of Chaney products, Chaney provides the benefits and services set forth herein.

We warrant that all products we manufacture under this warranty are of good material and workmanship and, when properly installed and operated, will be free of defects for a period of one year from the date of purchase.

Any product which, under normal use and service, is proven to breach the warranty contained herein within ONE YEAR from date of sale will, upon examination by us, and at our sole option, be repaired or replaced by us. Transportation costs and charges for returned goods shall be paid for by the purchaser. We hereby disclaim all responsibility for such transportation costs and charges. This warranty will not be breached, and we will give no credit for products which have received normal wear and tear not affecting the functionality of the product, been damaged (including by acts of nature), tampered, abused, improperly installed, or repaired or altered by others than our authorized representatives.

Remedy for breach of this warranty is limited to repair or replacement of the defective item(s). If we determine that repair or replacement is not feasible, we may, at our option, refund the amount of the original purchase price.

THE ABOVE-DESCRIBED WARRANTY IS THE SOLE WARRANTY FOR THE PRODUCTS AND IS EXPRESSLY IN LIEU OF ALL OTHER WARRANTIES, EXPRESS OR IMPLIED. ALL OTHER WARRANTIES OTHER THAN THE EXPRESS WARRANTY SET FORTH HEREIN ARE HEREBY EXPRESSLY DISCLAIMED, INCLUDING WITHOUT LIMITATION THE IMPLIED WARRANTY OF MERCHANTABILITY AND THE IMPLIED WARRANTY OF FITNESS FOR A PARTICULAR PURPOSE.

We expressly disclaim all liability for special, consequential, or incidental damages, whether arising in tort or by contract from any breach of this warranty. Some states do not allow the exclusion or limitation of incidental or consequential damages, so the above limitation or exclusion may not apply to you.

We further disclaim liability from personal injury relating to our products to the extent permitted by law. By acceptance of any of our products, the purchaser assumes all liability for the consequences arising from their use or misuse. No person, firm or corporation is authorized to bind us to any other obligation or liability in connection with the sale of our products. Furthermore, no person, firm or corporation is authorized to modify or waive the terms of this warranty unless done in writing and signed by a duly authorized agent of ours.

In no case shall our liability for any claim relating to our products, your purchase or your use thereof, exceed the original purchase price paid for the product.

Applicability of Policy

This Return, Refund, and Warranty Policy applies only to purchases made in the United States and Canada. For purchases made in a country other than the United States or Canada, please consult the policies applicable to the country in which you made your purchase.

Additionally, this Policy applies only to the original purchaser of our products. We cannot and do not offer any return, refund, or warranty services if you buy products used or from resale sites such as eBay or Craigslist.

Governing Law

This Return, Refund, and Warranty Policy is governed by the laws of the United States and the State of Wisconsin. Any dispute relating to this Policy shall be brought exclusively in the federal or State courts having jurisdiction in Walworth County, Wisconsin; and purchaser consents to jurisdiction within the State of Wisconsin.

ACU>RITE®



Weather
Stations



Temperature
and Humidity



Weather
Alert Radio



Kitchen
Thermometers
and Timers



Clocks

It's more than accurate, it's ACU>RITE.

AcuRite offers an extensive assortment of precision instruments, designed to provide you with information you can depend on to Plan your day with confidence™.