

AcuRite Iris™ (5-in-1) Weather Station with Color Display and PC Connect

model 01536



CONTENTS

Unpacking Instructions	2	PC Connect	13
Package Contents	2	Weather Underground	13
Product Registration.....	2	Rainfall Tracking	14
Features & Benefits: AcuRite Iris.....	3	Weather Ticker.....	15
Features & Benefits: Display	4	Programmable Alarms	16
Setup	7	Troubleshooting	17
AcuRite Iris Sensor Setup	7	Care & Maintenance	20
Display Setup.....	8	Calibration	20
Set the Time, Date & Units	9	Specifications.....	22
Backlight Settings.....	9	FCC Information	22
Placement Guidelines	10	Customer Support.....	23
AcuRite Iris Sensor Installation.....	11	Warranty.....	23
Using the Weather Center.....	12		

Questions? Visit www.acurite.com/support

SAVE THIS MANUAL FOR FUTURE REFERENCE.



Congratulations on your new AcuRite product. To ensure the best possible product performance, please read this manual in its entirety and retain it for future reference.

Unpacking Instructions

Remove the protective film that is applied to the LCD screen prior to using this product. Locate the tab and peel off to remove.

Package Contents

1. Display with Tabletop Stand
2. AcuRite Iris Sensor
3. Sensor Mounting Bracket
4. Mounting Hardware
5. Power Adapter
6. USB Cable
7. Instruction Manual

IMPORTANT

PRODUCT MUST BE REGISTERED
TO RECEIVE WARRANTY SERVICE

PRODUCT REGISTRATION

Register online to receive 1-year warranty protection
www.acurite.com/product-registration

Features & Benefits

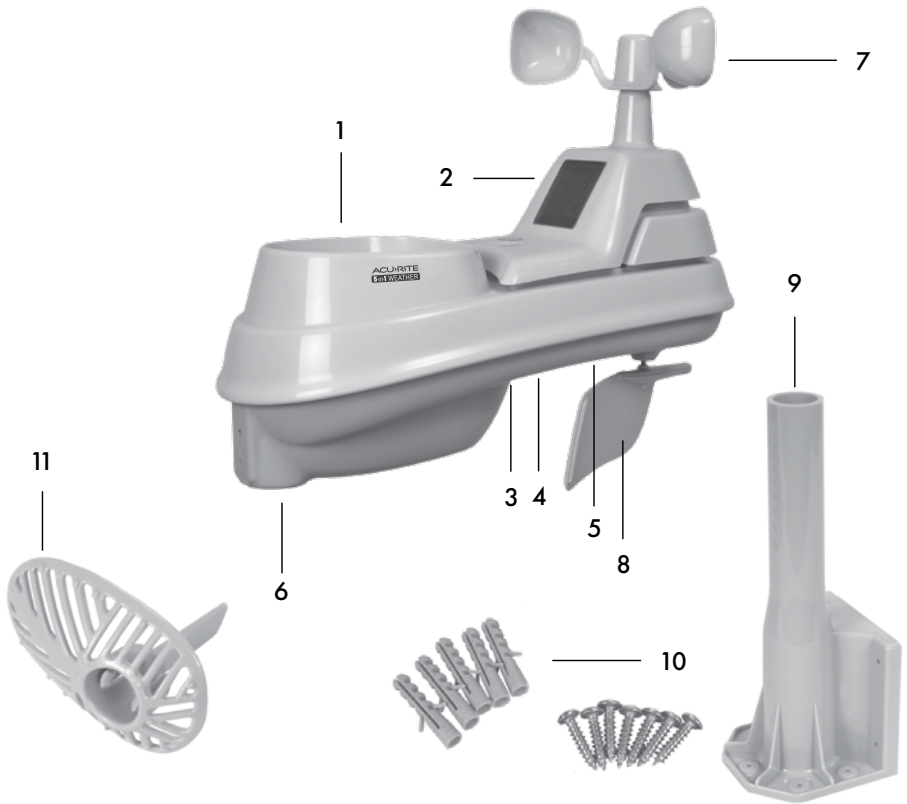

AcuRite Iris SENSOR

1. Rainfall Collector Funnel

2. Solar Cell Panel

Converts sunlight into power to run internal aspirating fan.

Internal Aspirating Fan (not shown)

Draws ambient air into sensor to reduce solar radiation heating, resulting in more accurate temperature measurement.

3. A-B-C Switch

ID code that must match display's A-B-C switch to ensure units synchronize.

4. Battery Compartment

5. Temperature & Humidity Sensors (internal)

6. Mounting Point

7. Wind Speed Anemometer

8. Wind Direction Vane

9. Mounting Bracket

10. Mounting Hardware

Includes 5 anchors & the following screws:

Qty	Diameter	Length
5	#4	3/4"
1	#4	1/2"
1	#6	1/2"

11. Debris Filter

Pre-installed to prevent debris from entering the rain gauge.

Features & Benefits

Display

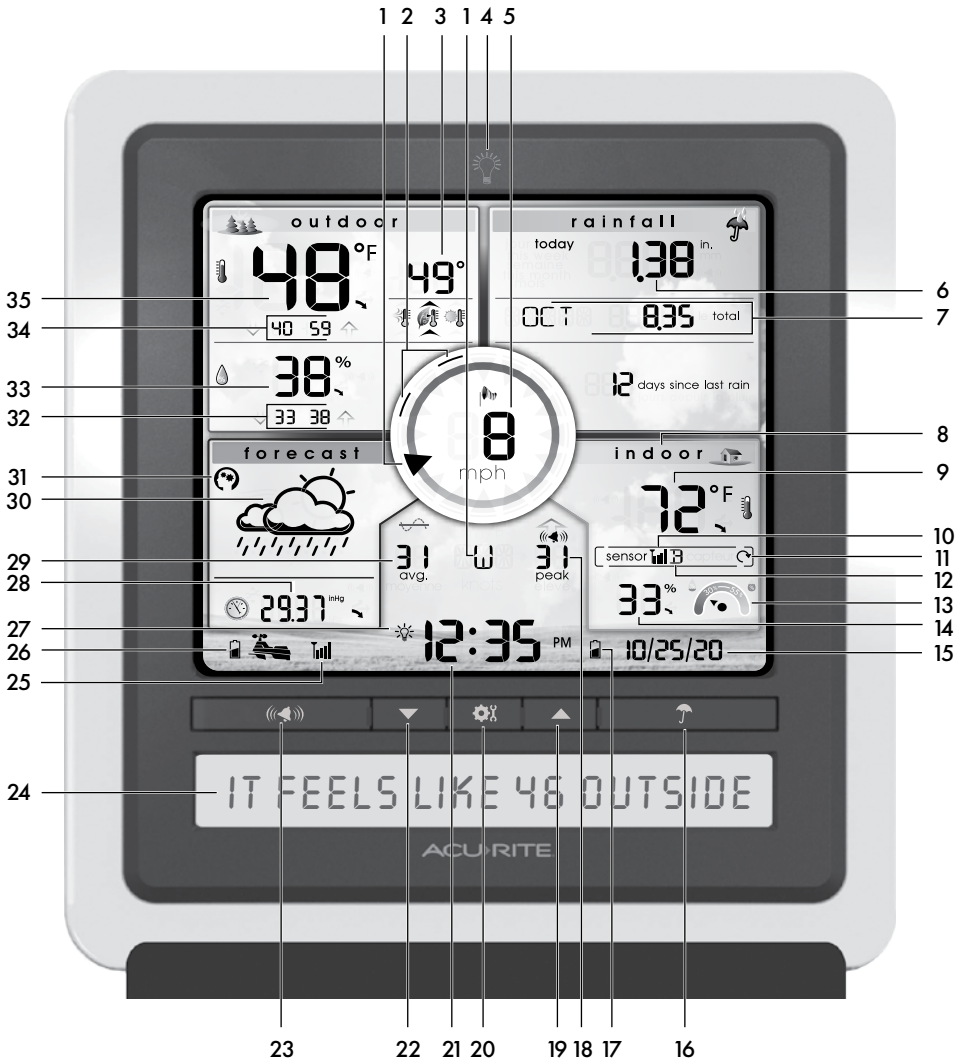

- 1. Current Wind Direction**
- 2. Previous 2 Wind Directions**
- 3. Seasonal Display**
Heat Index calculation displays when temperature is 80°F (27°C) or higher. Dew Point calculation displays when temperature is 79°F (26°C) or below. Wind chill calculation displays when temperature is 40°F (4°C) or lower.
- 4.  Button**
For momentary backlight and dimmer settings.
- 5. Current Wind Speed**
- 6. Rainfall**
Displays most recent rainfall total (today, this week or this month).
- 7. Rainfall History**
Displays historical rainfall totals (see page 14).
- 8. Indoor Indicator**
Indicates indoor (display unit) conditions are being shown.
- 9. Current Temperature for #8 or #12**
Arrow icon indicates direction temperature is trending.
- 10. Add-On Sensor Signal Strength**
If applicable (see page 13).
- 11. Auto-Cycle Indicator**
Indicates auto-cycle mode is enabled. If applicable (see page 13).
- 12. Add-On Sensor Indicator**
If applicable (see page 13).
- 13. Humidity Level Indicator**
Indicates a high, low, or ideal humidity comfort level.
- 14. Current Humidity for #8 or #12**
Arrow icon indicates direction humidity is trending.
- 15. Date**
- 16.  Button**
Press to view rainfall records (#6 and #7).
- 17. Display Low Battery Icon**
- 18. Peak Wind Speed**
Highest speed from the last 60 minutes.
- 19.  Button**
For setup preferences and manually cycling through Weather Ticker messages (when display is not connected to additional sensors). For manually cycling add-on sensor data (when display is connected to additional sensors).
- 20.  Button**
For setup preferences.
- 21. Clock**
- 22.  Button**
For setup preferences and manually cycling through Weather Ticker messages (when display is not connected to additional sensors). For manually cycling add-on sensor data (when display is connected to additional sensors).
- 23.  Button**
For alarm setup preferences.
- 24. Weather Ticker™**
Streams real-time data (see page 15).
- 25. Sensor Signal Strength**
- 26. Sensor Low Battery Icon**
- 27.  Icon**
Indicates display is in auto-dimming brightness mode (see page 9).
- 28. Barometric Pressure**
Arrow icon indicates direction pressure is trending.
- 29. Average Wind Speed**
Average wind speed over the past 2 minutes.
- 30. 12 to 24 Hour Weather Forecast**
Self-Calibrating Forecasting pulls data from your AcuRite Iris sensor to generate your personal forecast.
- 31.  Learning Mode Icon**
Disappears after weather forecast self-calibration is complete (see page 12).
- 32. High/Low Humidity Records**
Highest and lowest outdoor humidity recorded since midnight.
- 33. Current Outdoor Humidity**
Arrow icon indicates direction humidity is trending.
- 34. High/Low Temperature Records**
Highest and lowest outdoor temperature recorded since midnight.
- 35. Current Outdoor Temperature**
Arrow icon indicates direction temperature is trending.

Back of Display



BACK OF DISPLAY

- 1. Plug-in for Power Adapter**
- 2. Plug-in for USB Cable**
- 3. Integrated Keyhole**
For easy wall mounting.
- 4. DEVICE ID**
12 digit unique ID required for online connectivity functions.
- 5. Backup Battery Compartment**
- 6. A-B-C Switch**
ID code that must match AcuRite Iris sensor's A-B-C switch to ensure units synchronize.
- 7. CLEAR RECORD / RESET Button**
Press and HOLD for 8 seconds to clear all records. Press and HOLD for 10 seconds for full reset to factory defaults.
- 8. Power Adapter**
- 9. USB Cable for PC Connection**
- 10. Battery Compartment Cover**
(not shown)

AcuRite Iris Sensor Setup

1 Set the A-B-C Switch

Locate the A-B-C switch inside the battery compartment. Set the A-B-C switch to A, B or C. You must select the same letter choices for both the sensor and the display in order for the units to synchronize.

2 Install or Replace Batteries

Batteries **MUST** be installed for this product to operate. AcuRite recommends high quality alkaline or lithium batteries for the best product performance. Heavy duty or rechargeable batteries are not recommended.

The AcuRite Iris sensor requires lithium batteries in low temperature conditions. Cold temperatures can cause alkaline batteries to function improperly. Use

lithium batteries in the AcuRite Iris sensor for temperatures below -4°F / -20°C .

1. Slide off the battery compartment cover.
2. Insert 4 x AA batteries into the battery compartment, as shown. Follow the polarity (+/-) diagram in the battery compartment.
3. Replace the battery cover.

3 Remove Rain Gauge Stabilizer

Locate and remove the rain gauge stabilizer (plastic tab) taped into the bottom of the sensor. The rain gauge will not function until this is removed.

LITHIUM BATTERIES	-40°F (-40°C)	(70°C) 158°F
ALKALINE BATTERIES	-4°F (-20°C)	(70°C) 158°F

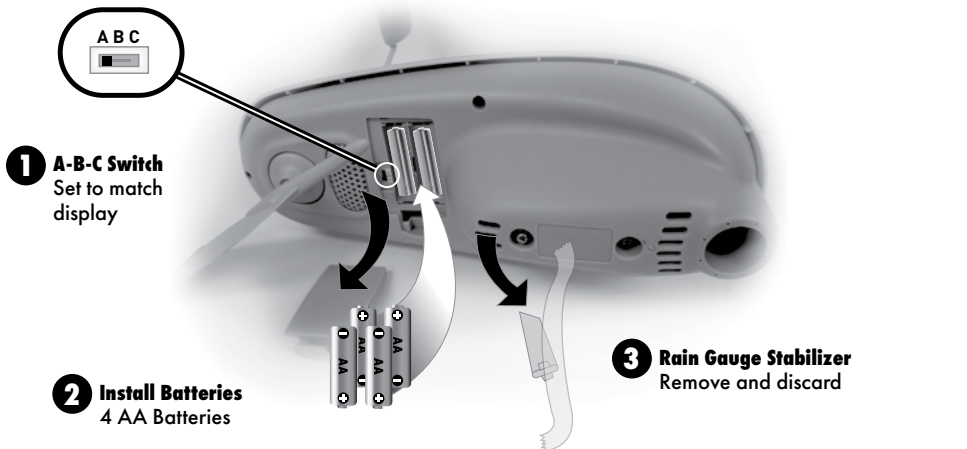

NOTE: If add-on sensors are being used with the display (see page 12), set them up at this time. If pairing more than one wireless sensor with the display, the A-B-C channel must differ between each add-on sensor. The display will automatically begin searching for add-on sensors during initial setup.

Display Setup

1 Set the A-B-C Switch

The A-B-C switch is located inside the battery compartment. It can be set to A, B or C. However, you must select the same letter choices for both the AcuRite Iris Sensor and the display in order for the units to synchronize.

2 Plug Power Adapter into Electric Outlet

1 A-B-C Switch set to match AcuRite Iris Sensor

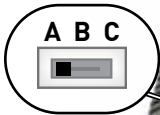

3 Write Down the DEVICE ID

12 digit unique ID needed for online connectivity functions.

4 Install or Replace Backup Batteries (optional)

Insert 3 x AA alkaline batteries into the battery compartment, as shown. Follow the polarity (+/-) diagram in the battery compartment.

3 Write Down DEVICE ID 12 digit number

4 Install Backup Batteries 3 AA Batteries

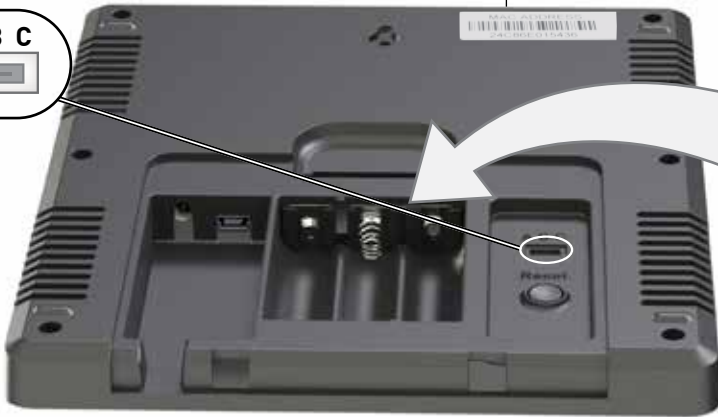
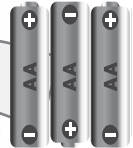

2 Plug in Power Adapter



IMPORTANT: Batteries are a backup power source to preserve records in the event of a power outage. Power adapter is the recommended primary power source to enjoy the full functionality of this product.



PLEASE DISPOSE OF OLD OR DEFECTIVE BATTERIES IN AN ENVIRONMENTALLY SAFE WAY AND IN ACCORDANCE WITH YOUR LOCAL LAWS AND REGULATIONS.

BATTERY SAFETY: Clean the battery contacts and also those of the device prior to battery installation. Remove batteries from equipment which is not to be used for an extended period of time. Follow the polarity (+/-) diagram in the battery compartment. Promptly remove dead batteries from the device. Dispose of used batteries properly. Only batteries of the same or equivalent type as recommended are to be used. DO NOT incinerate used batteries. DO NOT dispose of batteries in fire, as batteries may explode or leak. DO NOT mix old and new batteries or types of batteries (alkaline/standard). DO NOT use rechargeable batteries. DO NOT recharge non-rechargeable batteries. DO NOT short-circuit the supply terminals.

Set the Time, Date & Units

The display will automatically enter SET MODE after the unit has powered on. Once in set mode, the preference you are currently setting will blink on the display.

To adjust the currently selected (flashing) item, press and release the “▲” or “▼” buttons (press and HOLD to fast adjust).

To save your adjustments, press and release the “⚙️” button again to adjust the next preference. The preference set order is as follows:

LANGUAGE (English, French)
TIME ZONE (EST, CST, MST, PST, AKT, HAT, NST, AST)
AUTO DST CHANGE (YES, NO)*
WEATHER TICKER SPEED (SLOW, MEDIUM, FAST)
CLOCK HOUR
CLOCK MINUTE
CALENDAR MONTH
CALENDAR DATE
CALENDAR YEAR
TEMPERATURE UNITS (°F or °C)
WIND SPEED UNITS (mph, km/h, knots)
RAINFALL UNITS (inches or mm)
PRESSURE UNITS (inHg or hPa)

*If you live in an area that observes Daylight Saving Time, DST should be set to YES, even if it is not currently Daylight Saving Time.

You will automatically exit SET MODE if no buttons are pressed for 20 seconds. Enter setup mode at any time by pressing the “⚙️” button.

Display Backlight Settings

This weather station’s color display features three different lighting settings: High (100%) brightness, Medium (60%) brightness and Low (15%) brightness.

Using battery power alone, the backlight is available momentarily for 10 seconds by pressing the “💡” button.

When display is powered with the power adapter, backlight remains on at 100% brightness. Press the “💡” button once to dim to 60% brightness. Press again to dim to 15%. Press a 3rd time to enter “AUTO DIM” mode. The “💡” icon appears to the left of the time to indicate that auto-dim mode is ON.

NOTE: Pressing and holding the “💡” button for 5 seconds will disable the backlight. Once any button is pressed, the backlight will return to your selected setting.

AUTO DIM MODE: Automatically adjusts display brightness based on time of day.
6:00 a.m. - 9:00 p.m. = 100% brightness
9:01 p.m. - 5:59 a.m.= 15% brightness

Placement for Maximum Accuracy

AcuRite sensors are sensitive to surrounding environmental conditions. Proper placement of both the display and the sensor are critical to the accuracy and performance of this product.



Display Placement

Place the display in a dry area free of dirt and dust. To ensure accurate temperature measurement, place out of direct sunlight and away from heat sources or vents. Display stands upright for tabletop use or is wall-mountable.



AcuRite Iris Sensor Placement

The AcuRite Iris sensor is designed to remain outdoors all year long. Choose an open location with no obstructions above or around the sensor for the most accurate measurements.

Important Placement Guidelines

Display and sensor must be within 330 feet (100 meters) of each other.

MAXIMIZE WIRELESS RANGE

Place units away from large metallic items, thick walls, metal surfaces, or other objects that may limit wireless communication.

PREVENT WIRELESS INTERFERENCE

Place units at least 3 feet (.9 m) away from electronic devices (TV, computer, microwave, radio, etc.).

LOCATE AWAY FROM HEAT SOURCES

Position sensor away from heaters, air conditioners, chimneys, exhaust vents, asphalt and concrete (surfaces that radiate heat).

LOCATE AWAY FROM HUMIDITY SOURCES

Avoid installing the sensor near pools, spas, or other bodies of water. Water sources may impact humidity accuracy.

LOCATE AWAY FROM SPRINKLER HEADS

DO NOT install the sensor where it will be sprayed by a sprinkler system. This may force water inside the sensor.

LOCATE AWAY FROM WIND & RAIN OBSTRUCTIONS

DO NOT mount the sensor with obstructions around it. Consider a location that is a wide open area, with few structures around to ensure accurate wind measurement.

AcuRite Iris Sensor Installation Guidelines

INSTALLATION HEIGHT Mount the sensor at a minimum height of 5 feet (1.5 meters) off the ground, in an open area. Higher is better for wind measurements - the National Weather Service recommends 33 feet (10 meters) high!

MOUNTING OPTIONS The included mounting bracket is designed to screw directly onto wooden posts or surfaces that are 2" x 4" or larger. The sensor can also be mounted directly to 3/4" steel pipe (available at hardware stores and home centers).

SOLAR CELL INSTALLATION Install the sensor with the **solar cell facing SOUTH**. This ensures the cell receives as much sun as possible and orients wind direction.

AcuRite Iris Sensor Installation

1. Fasten mounting base (included) to a post or pole (not included) using the 4 longer screws included in the hardware bag.
2. Insert the mounting base into the hole on the bottom of the sensor.
3. Make sure the arrows on the top of the sensor are pointed in the proper direction and the bubble level is centered. The solar cell should be facing south to properly orient the wind direction.
4. Fasten the sensor into the mounting base using the 2 shorter screws included in the hardware bag.

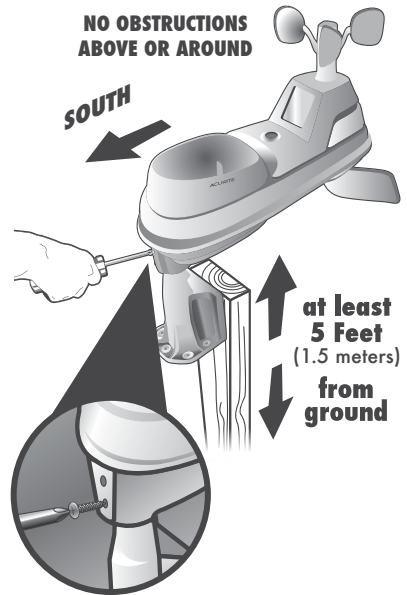

The AcuRite Iris sensor is now ready to use.

Clear Data Collected During Installation

When installation is complete, clear erroneous data from the display by pressing and **HOLDING** the "CLEAR RECORD/ RESET" button for 8 seconds, on the back of the display inside the battery compartment. This button will clear all records.

Basic Setup is Complete

The AcuRite Iris sensor will now synchronize with the display. It may take a few minutes for synchronization to complete. If both or one of the units appear to be functioning improperly, please refer to the troubleshooting section.





Using the Professional Weather Center

Learning Mode

Self-Calibrating Forecasting use a unique algorithm to analyze changes in pressure over a time period (called Learning Mode) to determine your altitude. After 14 days, the  icon disappears from the display screen. At this point, the self-calibrated pressure is tuned in to your location and the unit is ready for superior weather prediction.

Weather Forecast

AcuRite's patented Self-Calibrating Forecasting provides your personal forecast of weather conditions for the next 12 to 24 hours by collecting data from the sensor in your backyard. It generates a forecast with pinpoint accuracy - personalized for your exact location.

<p>STORMY & WINDY</p>  <p>(flashing=stormy)</p>	<p>SNOW LIKELY</p> 	<p>SNOW / RAIN MIX LIKELY</p> 	<p>RAIN LIKELY</p> 	<p>CLOUDY</p> 
---	---	--	---	--



View the complete list of icons at www.AcuRite.com/acurite-icons

Barometric Pressure

Subtle variations in barometric pressure greatly affect the weather. This weather center displays the current pressure with an arrow icon to indicate the direction the pressure is trending (FALLING, STEADY, or RISING).

Expand the System

The display features built-in sensors for measuring temperature and humidity at its location. The display can be expanded to track additional areas by using compatible Temperature & Humidity Sensors (optional; sold separately). Add up to 3 indoor/ outdoor sensors to observe conditions in additional locations within 330 ft (100 m). Compatible Sensors are available at: www.AcuRite.com

Compatible Sensors	Perfect for:
 <p>Temperature & Humidity Sensor Model 06002</p>	<ul style="list-style-type: none"> Indoor and outdoor applications
 <p>Temperature & Humidity Sensor Model 06044</p>	<ul style="list-style-type: none"> Integrated digital display for conditions at a glance Measures temperature and humidity For indoor applications

View Indoor/Add-On Sensor Readings

The weather station displays the current indoor temperature and humidity readings, by default. If the weather station is being used with additional sensors (see Expand the System), toggle between indoor readings and each sensor's readings by pressing and releasing the "▲" or "▼" buttons.

In auto-cycle mode, the display will automatically cycle through indoor and each sensor's data. Auto-cycle mode can be activated by pressing and releasing the "▲" or "▼" buttons until the "↻" indicator appears.

The Sensor Indicator is used to determine which add-on sensor readings you are viewing. For example, if the Sensor Indicator is displaying "A", the readings are being transmitted from the sensor with the A-B-C switch set to "A".

PC Connect

PC Connect works with PCs to provide access to your Weather Center data in the following ways:

- **Data File:** The display logs (or stores) data so that you can download it to a CSV (comma separated values) data file on your PC.
- **Web Browser or Smartphone:** Monitor sensor data remotely using AcuRite's free AcuRite online software, or from a mobile device using the free AcuRite app, available from the iOS App Store or Google Play Store.
- **Weather Underground:** This weather station is compatible for streaming data to the Weather Underground Personal Weather Station Network. For more information, navigate to: www.acurite.com > Support > Downloads

Download the Software

The PC Connect software is available online as a free download. A manual (PDF) is included with the software download.

Before setting up the PC Connect software, verify that the display is ON with the power adapter plugged in. Next, connect the mini-USB (small end of the cable) into the USB port on the display, located inside the battery compartment.



- 1** Download PC Connect software to your computer by visiting: **www.acurite.com > Support > Downloads**
- 2** Open the file that was downloaded in step 1 and follow the on-screen instructions to install the software.
- 3** After PC Connect is installed on the computer, the initial configuration will begin automatically. Select where to save weather data downloaded from the display. By default, this will create a folder named "AcuRite Weather Station" in the Documents folder.

- 4** When prompted by the software to plug in the display, connect the USB (larger end of the cable) into a USB port on the computer.

PC Connect is installed and ready for use.

Follow the instructions within the PC Connect app to complete setup and begin using the software.



Rainfall Tracking

This weather station features enhanced tracking of historical rainfall data.

Rain accumulation data is displayed for the current day, week, or month (most recent rainfall total). Press the “” button to review historical rainfall records.

Records are shown in the following order:

CURRENT YEAR TOTAL (default)

PREVIOUS MONTHLY TOTALS WITH RAIN (up to 12 months prior)

CURRENT YEAR TOTAL

PREVIOUS YEAR TOTAL

ALL-TIME TOTAL

Rainfall Data



TODAY

Displays rainfall recorded TODAY since 12:00am, if applicable.



WEEK

If there hasn't been any rainfall today, the current week's rainfall (Sunday to Saturday) is displayed, if applicable.



MONTH

If there hasn't been any rainfall this week, the current month's rainfall is displayed.

Rainfall History

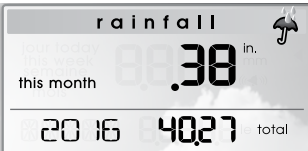

CURRENT YEAR TOTAL RAINFALL (default)

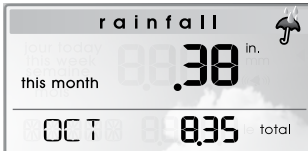

TOTAL RAINFALL FOR MONTH SHOWN

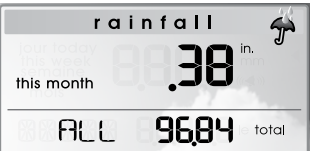

ALL-TIME TOTAL RAINFALL

Weather Ticker™

The Weather Ticker automatically flashes your real-time weather information and alerts as text in the lower part of the display unit screen.

The possible WEATHER TICKER messages are as follows:

HEAT INDEX-XX

WIND CHILL-XX

DEW POINT-XX

IT FEELS LIKE XX OUTSIDE

TODAY'S HIGH HUMIDITY...OUTDOOR XX / INDOOR XX

TODAY'S LOW HUMIDITY...OUTDOOR XX / INDOOR XX

TODAY'S HIGH TEMP...OUTDOOR XX / INDOOR XX

TODAY'S LOW TEMP...OUTDOOR XX / INDOOR XX

7 DAY HIGH TEMP. XX - MM/DD

7 DAY LOW TEMP. XX - MM/DD

30 DAY HIGH TEMP. XX - MM/DD

30 DAY LOW TEMP. XX - MM/DD

ALL TIME HIGH TEMP. XXX...RECORDED MM/DD/YY

ALL TIME LOW TEMP. XXX...RECORDED MM/DD/YY

24 HOUR TEMP. CHANGE +XX

ALL TIME HIGH WIND XX MPH...RECORDED MM/DD/YY

7 DAY AVERAGE WIND XX MPH

TODAY'S AVERAGE WIND XX MPH

MOON - NEW

MOON - WAXING CRESCENT

MOON - FIRST QUARTER

MOON - WAXING GIBBOUS

MOON - FULL

MOON - WANING GIBBOUS

MOON - LAST QUARTER

MOON - WANING CRESCENT

INDOOR HUMIDITY OK

INDOOR HUMIDITY HIGH

INDOOR HUMIDITY LOW

NEW LOW TEMP. RECORD XX

NEW HIGH TEMP. RECORD XX

NEW WIND RECORD TODAY XX

CURRENT RAINFALL X.XX/HR.

RAIN EVENT STARTED XX HRS. AGO

SENSOR BATTERIES LOW

DISPLAY BATTERIES LOW

SENSOR SIGNAL LOST...CHECK BATTERIES AND PLACEMENT

CAUTION- HEAT INDEX IS XXX

CAUTION- WIND CHILL IS XXX

CALIBRATION

DATA LOGGER FULL...CONNECT TO PC TO TRANSFER













Programmable Weather Alarms

Each selectable weather category features an alarm option. When an alarm sounds, the display emits audible beeping and flashes the affected category, its alarm settings, and any other relevant data.







Alarms can be customized to alert you when your programmed value is reached (high and low). Alarms include:

OUTDOOR TEMPERATURE
OUTDOOR HUMIDITY
BAROMETRIC PRESSURE
WIND SPEED
RAINFALL
INDOOR TEMPERATURE
INDOOR HUMIDITY

Setup an Alarm

1. Press and release the "" button to enter ALARM SET MODE.
2. Press and release the "" or "" buttons until the reading for which you wish to set an alarm is shown on the display.
3. Press and release the "" button.
4. Press and release the "" or "" buttons until "ON" is flashing on the Weather Ticker screen.
5. Press and release the "" button. The current HIGH alarm value will be shown.
6. Press and release the "" or "" buttons to adjust the alarm's HIGH value.
7. Press and release the "" button. The current LOW alarm value will be shown.
8. Press and release the "" or "" buttons to adjust the alarm's LOW value.
9. Press and release the "" button.
10. Repeat steps 1-9, as needed.

Disable an Alarm

1. Press and release the "" button to enter ALARM SET MODE.
2. Press and release the "" or "" buttons until the reading for which you wish to disable is shown on the display.
3. Press and release the "" button.
4. Press and release the "" or "" buttons until "OFF" is flashing on the Weather Ticker screen.
5. Press and release the "" button.
6. Repeat steps 1-5, as needed.

NOTE: To disable ALL alarms at once, press and HOLD the "" button for 15 seconds.

Troubleshooting

Problem	Possible Solution
<p data-bbox="110 423 306 480">No outdoor sensor reception</p>  <p data-bbox="200 505 274 524">no bars</p>	<ul style="list-style-type: none"> <li data-bbox="387 207 919 261">• Relocate the display and/or the AcuRite Iris sensor. The units must be within 330 ft (100 m) of each other. <li data-bbox="387 269 998 375">• Make sure both units are placed at least 3 feet (.9 m) away from electronics that may interfere with the wireless communication (such as TVs, microwaves, computers, etc). <li data-bbox="387 383 990 521">• Use standard alkaline batteries (or lithium batteries in sensor when temperature is below -20°C/-4°F). Do not use heavy duty or rechargeable batteries. NOTE: It may take a few minutes for display and sensor to synchronize after batteries are replaced. <li data-bbox="387 529 979 740">• Synchronize the units: <ol style="list-style-type: none"> <li data-bbox="400 561 940 615">1. Bring both the sensor and display indoors and remove power adapter/batteries from each. <li data-bbox="400 623 770 643">2. Reinstall batteries in outdoor sensor. <li data-bbox="400 651 855 670">3. Reinstall power adapter/batteries in display. <li data-bbox="400 678 976 732">4. Let the units sit within a couple feet of each other for a few minutes to gain a strong connection.
<p data-bbox="123 821 293 943">Outdoor temperature is flashing or showing dashes</p>	<p data-bbox="378 797 958 850">Flashing of the outdoor temperature may be an indication of wireless interference.</p> <ul style="list-style-type: none"> <li data-bbox="387 859 985 964">• Make sure the A-B-C switch in the battery compartments of both the display and sensor are switched to the same letter. You may choose A, B or C; but both units must match to sync up. Sometimes changing to a different channel can help.
<p data-bbox="110 1151 306 1175">Inaccurate forecast</p>	<ul style="list-style-type: none"> <li data-bbox="387 1040 976 1094">• Weather Forecast icon predicts conditions for the next 12 to 24 hours, not current conditions. <li data-bbox="387 1102 979 1175">• Has Learning Mode icon disappeared from the display? Learning Mode must complete before forecast and pressure will be accurate. <li data-bbox="387 1183 976 1289">• Allow unit to run continuously for 33 days. Battery removal or resetting the display will restart Learning Mode. After 14 days, forecast should be fairly accurate, however Learning Mode calibrates for a total of 33 days.

Troubleshooting

Problem	Possible Solution
<p>Inaccurate temperature or humidity</p>	<ul style="list-style-type: none"> • Make sure both the display and AcuRite Iris sensor are placed away from any heat sources or vents (see page 10). • Make sure both units are positioned away from moisture sources (see page 10). • Make sure AcuRite Iris sensor is mounted at least 1.5 m (5 ft) off of the ground. • Calibrate indoor and outdoor temperature and humidity (see page 20).
<p>No rainfall</p>	<ul style="list-style-type: none"> • Check to ensure the rain gauge stabilizer (plastic tab) has been removed from the bottom of the sensor (see page 7). • Clear debris, such as leaves, out of the rain collector funnel and debris screen. • Calibrate the Rain Gauge (see page 21).
<p>Inaccurate wind readings</p>	<ul style="list-style-type: none"> • What is wind reading being compared to? Pro weather stations are typically mounted at 30 ft (9 m) high or more. Make sure to compare data using a sensor positioned at the same mounting height. • Check location of the sensor. Ensure it's mounted a minimum of 5 ft (1.5 m) in the air with no obstructions around it (within several feet). • Ensure wind cups are spinning freely. If they hesitate or stop try lubricating with graphite powder or spray lubricant.
<p>Display screen not working</p>	<ul style="list-style-type: none"> • Check that the batteries are installed correctly. Batteries may need to be replaced. • Reset the display by pressing and holding the CLEAR RECORD / RESET button for 10 seconds, located in the battery compartment of the display. Date and time will need to be entered after a reset.

If your AcuRite product does not operate properly after trying the troubleshooting steps, visit www.acurite.com/support.

Troubleshooting

Problem	Possible Solution
<p>Cannot access data online or on the AcuRite mobile app</p>	<ul style="list-style-type: none"> • Verify under Status that data was received from the indoor display. The timestamp should update every 18-36 seconds. • Verify that you created an account or logged into an existing account at www.MyAcuRite.com or in the AcuRite app, and that you input the display's DEVICE ID as a part of the account setup. • Verify the PC that the display is connected to is always powered ON. • Verify the PC that the display is connected to is always connected to the internet. • Verify that the display's DEVICE ID is entered correctly in the PC Connect software on your PC. • Verify that "Sharing" is enabled in the PC Connect software on your PC. • Verify that the display's DEVICE ID is correct in your www.MyAcuRite.com and/or AcuRite mobile app account. • Follow on-screen troubleshooting steps in the PC Connect software.
<p>No data received from indoor display</p>	<ul style="list-style-type: none"> • Verify that the USB cable is securely connected to the display AND to the PC. • Verify the display is powered ON. • Restart the PC Connect software. • Unplug the USB cable from the PC for 1 minute, then plug the cable back in again. • USB port may be malfunctioning, try using a different USB port.
<p>Add-on Sensor not recognized</p>	<p>If the display is being used with add-on Temperature & Humidity Sensors (models 06002 or 06044), the A-B-C channels must differ between each add-on sensor.</p> <ol style="list-style-type: none"> 1. Bring the display and wireless sensors together and position them side-by-side. 2. Unplug cord & remove the batteries from the display. 3. Verify that each sensor has a different A-B-C channel selected. <ul style="list-style-type: none"> • Model 06002 - Locate the A-B-C switch inside the battery compartment to adjust channel setting. • Model 06044 - Locate the A-B-C button on the back of the sensor to adjust channel setting (indicated on sensor display). 4. Re-install sensor batteries (if applicable). 5. Plug in & re-install display batteries. <p>NOTE: It may take a few minutes for the display and sensor(s) to synchronized after batteries are replaced.</p>

Care & Maintenance

Display Care

Clean with a soft, damp cloth. Do not use caustic cleaners or abrasives. Keep away from dust, dirt and moisture. Clean ventilation ports regularly with a gentle puff of air.

AcuRite Iris Sensor Care

Clean the Sensor

Clean with a soft damp cloth. Do not use caustic cleaners or abrasives that will mar the polished surfaces of the rain collection funnel or the solar cell. Scratches will result in decreased performance and reliability.

Insect Prevention

Insects may cause obstructions and interrupt data by nesting in or on the AcuRite Iris sensor. To limit this problem, spray sensor with a household insect repellent. Consult the insect repellent instructions prior to use.

Snow & Freezing Weather

The AcuRite Iris sensor will not be damaged by freezing conditions. NOTE: If the rain collector cup fills with snow and then melts, it will register as rain on the display.

Clean the Rain Collector Cup

Remove and empty rain collector debris filter. The debris filter is located in the rain collector funnel. Remove from the top by gently squeezing and pulling out.

Clean the Wind Vane & Anemometer

Remove foreign matter from the outside of the sensor for free movement of the wind vane and anemometer. If needed, use a small amount of spray lubricant, clear silicone or graphite powder on the anemometer for improved movement.

Calibration

The indoor and outdoor temperature and humidity readings, and barometric pressure can be calibrated on the display to improve accuracy. Calibration can improve accuracy when sensor placement or environmental factors impact the data accuracy.

1. To access calibration mode, press AND HOLD the "▲", "⚙️", and "▼" buttons simultaneously for at least 5 seconds.
2. To adjust the currently selected (flashing) item, press and release the "▲" or "▼" buttons to calibrate the data value higher or lower from the actual reading.
3. To save your adjustments, press and release the "⚙️" button to adjust the next preference. The "🔌" icon will remain illuminated next to calibrated values.

The preference set order is as follows:

OUTDOOR TEMPERATURE

OUTDOOR HUMIDITY

INDOOR TEMPERATURE

INDOOR HUMIDITY

BAROMETRIC PRESSURE (must be set to MANUAL mode to calibrate)*

*To change from AUTO to MANUAL pressure mode and vice versa, press AND HOLD the "⚙️" button for 5-7 seconds. The display indicates the current pressure mode selected, "AUTO" or "MANUAL". The "☂️" icon will appear next to the barometric pressure to indicate that MANUAL mode has been activated. Press and HOLD the "⚙️" button for 5-7 seconds to return to AUTO mode.

After 5-10 seconds of inactivity, the display will save the adjustments and exit calibration mode.

NOTE: Calibrations will be erased if the display is reset or if batteries are removed and the power adapter is unplugged.

Calibrate the Rain Gauge

The rain gauge on the AcuRite Iris sensor can be calibrated to improve accuracy.

Items Needed: AcuRite Iris sensor, display, plastic cup, pin, screw driver

1. First, ensure AcuRite Iris sensor is perfectly level using built-in bubble level.
2. Place display close so you can monitor it during calibration.
3. Make a pin hole in the bottom of a plastic cup. Hold the cup over the rain gauge and fill it with exactly 1 cup (8oz) of water, allowing the water to drip into the rain gauge. You should hear the internal buckets tip and see water drain through the rain gauge.
4. A few seconds after each bucket tip, the display displays rainfall in approximately 0.01" (.25 mm) or more increments.
5. The cup of water should take more than 20 minutes to empty; a quicker period will result in inaccurate calibration. Try to simulate a normal steady rainfall. When cup is empty of water, display should register 1.06" (27 mm).

Tips

- There should be nearly an equal number of water drops (about 25 water drops) between bucket tips. If not, adjust the calibration screws on the bottom of the AcuRite Iris sensor until an equal number of water drops are tipping the buckets. Then, restart the calibration procedure.
- If you don't hear the buckets tipping and see water dripping alternately out of each drain, there may be an issue with the rain gauge or it's adjustment. See Troubleshooting on page 18.

Adjustment

If the rain gauge doesn't register close to 1.06" (27 mm), make an EQUAL adjustment to the two calibration screws on the bottom of the AcuRite Iris sensor. Turning screws clockwise increases rainfall; counter clockwise decreases rainfall.

- To adjust the rainfall reading by 2% turn both screws 1/8 of a turn.
- To adjust the rainfall reading by 4% turn both screws 1/4 of a turn.
- To adjust the rainfall reading by 8% turn both screws 1/2 of a turn.

Specifications

TEMPERATURE RANGE	Outdoor: -40°F to 158°F; -40°C to 70°C
	Indoor: 32°F to 122°F; 0°C to 50°C
HUMIDITY RANGE	Outdoor: 1% to 99%
	Indoor: 1% to 99%
WIND SPEED	0 to 99 mph; 0 to 159 km/h
WIND DIRECTION INDICATORS	16 points
RAINFALL	0.01 inches (0.25 mm) and up
WIRELESS RANGE	330ft / 100m depending on home construction materials
OPERATING FREQUENCY	433 MHz
POWER	Display: 5V AC, 250mA adapter 3 x AA alkaline batteries (optional)
	Sensor: 4 x AA alkaline or lithium batteries
DATA REPORTING	Wind Speed: 18 second updates; Direction: 30 seconds Outdoor temperature & humidity: 36 second updates Indoor temperature & humidity: 60 second updates PC Connect CSV Data Logging: 12 minute intervals PC Connect to AcuRite Software/App: 18 seconds
DISPLAY MEMORY	512 kilobytes (not expandable)
PC CONNECT SYSTEM REQUIREMENTS	Mac OSX 10.9 (Mavericks) or higher
	Windows 10 / 8.1 / 8 / 7; 1 GHz or faster processor; 1 GB (32-bit) or 2 GB (64-bit) of RAM; available USB 2.0 port
	High speed internet is required for some advanced features of PC Connect, such as Weather Underground Rapid Fire Updates.

FCC Information

This device complies with part 15 of FCC rules. Operation is subject to the following two conditions:

- 1- This device may NOT cause harmful interference, and
- 2- This device must accept any interference received, including interference that may cause undesired operation.

WARNING: Changes or modifications to this unit not expressly approved by the party responsible for compliance could void the user's authority to operate the equipment.

NOTE: This equipment has been tested and found to comply with the limits for a Class B digital device, pursuant to Part 15 of the FCC rules. These limits are designed to provide reasonable protection against harmful interference in a residential installation. This equipment generates, uses and can radiate radio frequency energy and, if not installed and used in accordance with the instructions, may cause harmful interference to radio communications.

However, there is no guarantee that interference will not occur in a particular installation. If this equipment does cause harmful interference to radio or television reception, which can be determined by turning the equipment off and on, the user is encouraged to try to correct the interference by one or more of the following measures:

- Reorient or relocate the receiving antenna.
- Increase the separation between the equipment and the receiver.
- Connect the equipment into an outlet on a circuit different from that to which the receiver is connected.
- Consult the dealer or an experienced radio/TV technician for help.

NOTE: The manufacturer is not responsible for any radio or TV interference caused by unauthorized modifications to this equipment. Such modifications could void the user authority to operate the equipment.

This device complies with Industry Canada licence-exempt RSS standard(s).

Operation is subject to the following two conditions:

- (1) This device may not cause interference, and
- (2) This device must accept any interference received, including interference that may cause undesired operation of the device.

Customer Support

AcuRite customer support is committed to providing you with best-in-class service. **For assistance**, please have the model number of this product available and contact us in any of the following ways:



Chat with our support team at www.acurite.com/support



Email us at support@chaney-inst.com

- ▶ Installation Videos
- ▶ Instruction Manuals
- ▶ Replacement Parts

IMPORTANT

PRODUCT MUST BE REGISTERED
TO RECEIVE WARRANTY SERVICE

PRODUCT REGISTRATION

Register online to receive 1-year warranty protection
www.acurite.com/product-registration

Limited 1-Year Warranty

AcuRite is a wholly owned subsidiary of Chaney Instrument Company. For purchases of AcuRite products, AcuRite provides the benefits and services set forth herein.

For purchases of Chaney products, Chaney provides the benefits and services set forth herein. We warrant that all products we manufacture under this warranty are of good material and workmanship and, when properly installed and operated, will be free of defects for a period of one year from the date of purchase.

Any product which, under normal use and service, is proven to breach the warranty contained herein within ONE YEAR from date of sale will, upon examination by us, and at our sole option, be repaired or replaced by us. Transportation costs and charges for returned goods shall be paid for by the purchaser. We hereby disclaim all responsibility for such transportation costs and charges. This warranty will not be breached, and we will give no credit for products which have received normal wear and tear not affecting the functionality of the product, been damaged (including by acts of nature), tampered, abused, improperly installed, or repaired or altered by others than our authorized representatives.

Remedy for breach of this warranty is limited to repair or replacement of the defective item(s). If we determine that repair or replacement is not feasible, we may, at our option, refund the amount of the original purchase price.

THE ABOVE-DESCRIBED WARRANTY IS THE SOLE WARRANTY FOR THE PRODUCTS AND IS EXPRESSLY IN LIEU OF ALL OTHER WARRANTIES, EXPRESS OR IMPLIED. ALL OTHER WARRANTIES OTHER THAN THE EXPRESS WARRANTY SET FORTH HEREIN ARE HEREBY EXPRESSLY DISCLAIMED, INCLUDING WITHOUT LIMITATION THE IMPLIED WARRANTY OF MERCHANTABILITY AND THE IMPLIED WARRANTY OF FITNESS FOR A PARTICULAR PURPOSE.

We expressly disclaim all liability for special, consequential, or incidental damages, whether arising in tort or by contract from any breach of this warranty. Some states do not allow the exclusion or limitation of incidental or consequential damages, so the above limitation or exclusion may not apply to you.

We further disclaim liability from personal injury relating to its products to the extent permitted by law. By acceptance of any of our products, the purchaser assumes all liability for the consequences arising from their use or misuse. No person, firm or corporation is authorized to bind us to any other obligation or liability in connection with the sale of our products. Furthermore, no person, firm or corporation is authorized to modify or waive the terms of this warranty unless done in writing and signed by a duly authorized agent of ours.

In no case shall our liability for any claim relating to our products, your purchase or your use thereof, exceed the original purchase price paid for the product.

Applicability of Policy

This Return, Refund, and Warranty Policy applies only to purchases made in the United States and Canada. For purchases made in a country other than the United States or Canada, please consult the policies applicable to the country in which you made your purchase. Additionally, this Policy applies only to the original purchaser of our products. We do not and do not offer any return, refund, or warranty services if you buy products used or from resale sites such as eBay or Craigslist.

Governing Law

This Return, Refund, and Warranty Policy is governed by the laws of the United States and the State of Wisconsin. Any dispute relating to this Policy shall be brought exclusively in the federal or State courts having jurisdiction in Walworth County, Wisconsin; and purchaser consents to jurisdiction within the State of Wisconsin.

ACU RITE®

www.AcuRite.com