

Professional Weather Center

model 01500/01515



CONTENTS

Unpacking Instructions	2	5-in-1 Sensor Installation.....	12
Package Contents	2	Using the Weather Center	13
Product Registration	2	Weather Ticker	14
Features & Benefits: 5-in-1	3	Programmable Alarms.....	16
Features: Display Unit	4	Troubleshooting	18
Back of Display Unit.....	6	Care & Maintenance.....	20
Setup	7	Calibration	20
5-in-1 Sensor Setup	7	Specifications.....	22
Display Unit Setup	8	FCC Information	22
Set the Time & Date	9	Customer Support	23
Measurement Units	10	Warranty.....	23
Placement Guidelines	11		

Questions? Contact Customer Support at (877) 221-1252 or visit www.AcuRite.com.

SAVE THIS MANUAL FOR FUTURE REFERENCE.



Congratulations on your new AcuRite product. To ensure the best possible product performance, please read this manual in its entirety and retain it for future reference.

Unpacking Instructions

Remove the protective film that is applied to the LCD screen prior to using this product. Locate the tab and peel off to remove.

Package Contents

1. Display unit with tabletop stand
2. 5-in-1 sensor
3. Sensor mounting bracket
4. Mounting hardware
5. Snap-in debris filter for rain collector
6. Power adapter
7. Instruction Manual

IMPORTANT

PRODUCT MUST BE REGISTERED
TO RECEIVE WARRANTY SERVICE

PRODUCT REGISTRATION

Register online
to receive 1 year
warranty protection

www.AcuRite.com

REGISTER NOW

SUPPORT

Support Forum

Archived Products

▶ Register a Product

Features & Benefits

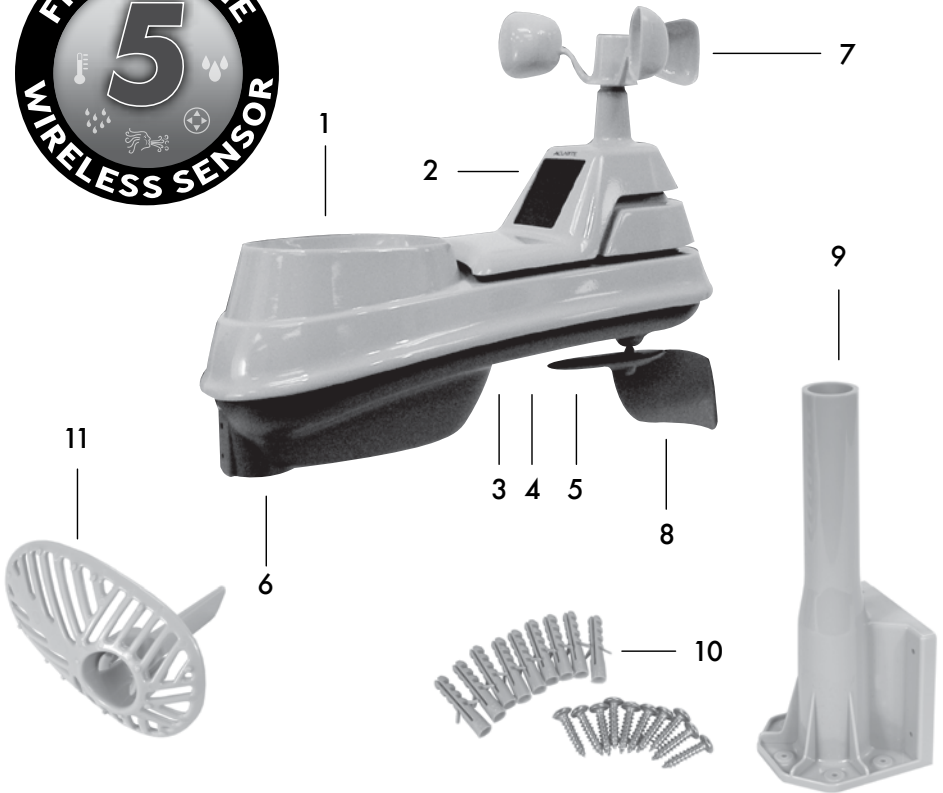

5-IN-1 SENSOR

1. Rainfall Collector Funnel

2. Solar Cell Panel

Converts sunlight into power to run internal aspirating fan.

Internal Aspirating Fan (not shown)

Draws ambient air into sensor to reduce solar radiation heating, resulting in more accurate temperature measurement.

3. A-B-C Switch

ID code that must match display's A-B-C switch to ensure units synchronize.

4. Battery Compartment

5. Temperature & Humidity Sensors (internal)

6. Mounting Point

7. Wind Speed Anemometer

8. Wind Direction Vane

9. Mounting Bracket

10. Mounting Hardware

Qty	Diameter	Length
4	#4	1"
2	#6	1/2"

11. Debris Filter

Snaps into rain collector to filter out twigs, leaves, etc.

Features & Benefits

Display Unit



- 1. Peak Wind Speed**
Highest speed from past 60 minutes.
- 2. Average Wind Speed**
of all speeds from past 2 minutes.
- 3. Learning Mode Icon**
Press to change the Weather Select category data being displayed.
- 4. Weather Select**
Heat index, dew point, wind chill, indoor temperature / humidity, rainfall rate (rain per hour)
- 5. 12 to 24 Hour Weather Forecast**
Self-Calibrating Forecasting pulls data from the outdoor sensor to generate your personal forecast.
- 6. Weather Select Button**
Press to change the Weather Select category data being displayed.
- 7. 5-in-1 Sensor Signal Strength**
- 8. Alarm On/Off Indicator**
for Selectable Category (#31).
- 9. Programmable Alarm Settings**
- 10. "✓" Icon**
Indicates active Weather Ticker message.
- 11. "X" Icon**
Indicates deactivated Weather Ticker message.
- 12. ALARM On/Off Button**
Activate alarm; press and hold to adjust alarm values.
- 13. "X remove" Button**
Deactivate Weather Ticker Message
- 14. ▲/▼ Buttons**
For category selection & setup preferences.
- 15. SET Button**
For setup preferences.
- 16. "↻" Button**
For manually cycling Weather Ticker messages.
- 17. HISTORY MODE Button**
Press for all-time low and date recorded for current category selected on display (#31). Press twice for all-time high and date recorded.
- 18. "add ✓" Button**
Activates Weather Ticker message.
- 19. Current Outdoor Temperature**
Arrow icon indicates direction temperature is trending.
- 20. Outdoor Temperature Alarm On Indicator**
- 21. Current Outdoor Humidity**
Arrow icon indicates direction humidity is trending.
- 22. Outdoor Humidity Alarm On Indicator**
- 23. Storm Alert Alarm On Indicator**
- 24. Current Rainfall**
Accumulates data during rainfall.
- 25. Rain Alarm On Indicator**
- 26. Current Barometric Pressure**
Arrow icon indicates direction pressure is trending.
- 27. All-Time Rainfall**
- 28. Current Month Total Rainfall**
- 29. Date**
- 30. Clock**
- 31. Selectable Category**
- 32. Record Highs**
Shown for current category selected on the display (#31).
- 33. Record Lows**
Shown for current category selected on the display (#31).
- 34. Weather Ticker™**
- 35. Current Wind Direction**
- 36. Previous 2 Wind Directions**
- 37. Touch Activated Backlight**
Momentary during battery power, always on/off for power adapter
- 38. Current Wind Speed**
- 39. Wind Speed Alarm On Indicator**

Back of Display Unit



BACK OF DISPLAY UNIT

- 1. Integrated Hang Hole**
for easy wall mounting
- 2. Plugin for Power Adapter**
- 3. A-B-C Switch**
ID code that must match 5-in-1 sensor's A-B-C switch to ensure units synchronize
- 4. CLEAR TODAY Button**
Clears data recorded since 12:00am
- 5. CLEAR ALL Button**
Clears all recorded data without having to reset time and date
- 6. RESET Button**
Full reset to factory defaults
- 7. Battery Compartment**
- 8. Power Adapter**
- 9. Battery Compartment Cover**
(not shown)

5-IN-1 Sensor Setup

1 Set the A-B-C Switch

Locate the A-B-C switch inside the battery compartment. Set the A-B-C switch to A, B or C. You must select the same letter choices for both the sensor and the display unit in order for the units to synchronize.

2 Install or Replace Batteries

Batteries **MUST** be installed for this product to operate. AcuRite recommends high quality alkaline or lithium batteries for the best product performance. Heavy duty or rechargeable batteries are not recommended.

The 5-in-1 sensor requires lithium batteries in low temperature conditions. Cold temperatures can

cause alkaline batteries to function improperly. Use lithium batteries in the 5-in-1 sensor for temperatures below -4°F / -20°C.

1. Slide off the battery compartment cover.
2. Insert 4 x AA batteries into the battery compartment, as shown. Follow the polarity (+/-) diagram in the battery compartment.
3. Replace the battery cover.

3 Remove Rain Gauge Stabilizer

Locate and remove the rain gauge stabilizer (plastic tab) taped into the bottom of the sensor. The rain gauge will not function until this is removed.

LITHIUM BATTERIES -40°F (-40°C) (70°C) 158°F

ALKALINE BATTERIES -4°F (-20°C) (70°C) 158°F

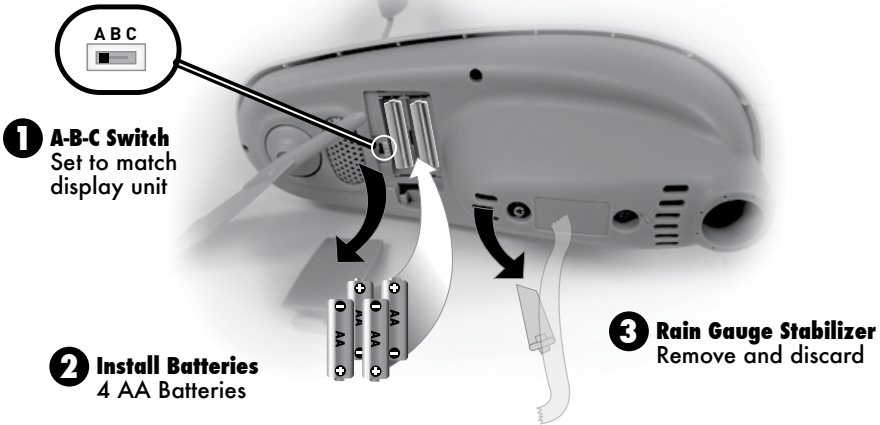

Display Unit Setup

The display unit operates with batteries and/or power adapter. Regardless of the power source, it is recommended that batteries always be installed to ensure continuous operation (and retain records) in case of a power outage.

1 Set the A-B-C Switch

The A-B-C switch is located inside the battery compartment. It can be set to A, B or C. However, you must select the same letter choices for both the sensor and the display unit in order for the units to synchronize.

2 Install or Replace Batteries

Insert 6 x AA alkaline batteries into the battery compartment, as shown. Follow the polarity (+/-) diagram in the battery compartment.

3 Plug Power Adapter into Electric Outlet (optional)

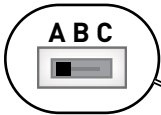

1 A-B-C Switch set to match sensor

2 Install Batteries 6 AA Batteries

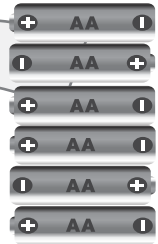



Momentary backlight during battery power. Backlight can always remain on (or off) when power adapter is plugged in.

LIGHT

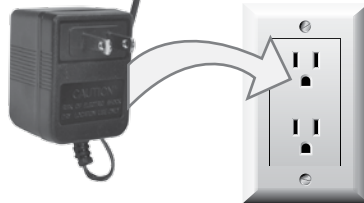

3 Plug in Power Adapter (optional)

PLEASE DISPOSE OF OLD OR DEFECTIVE BATTERIES IN AN ENVIRONMENTALLY SAFE WAY AND IN ACCORDANCE WITH YOUR LOCAL LAWS AND REGULATIONS.

BATTERY SAFETY: Clean the battery contacts and also those of the device prior to battery installation. Remove batteries from equipment which is not to be used for an extended period of time. Follow the polarity (+/-) diagram in the battery compartment. Promptly remove dead batteries from the device. Dispose of used batteries properly. Only batteries of the same or equivalent type as recommended are to be used. DO NOT incinerate used batteries. DO NOT dispose of batteries in fire, as batteries may explode or leak. DO NOT mix old and new batteries or types of batteries (alkaline/standard). DO NOT use rechargeable batteries. DO NOT recharge non-rechargeable batteries. DO NOT short-circuit the supply terminals.

Set the Time & Date

The clock and calendar are utilized to time stamp history records and other data, so it is important to set the time and date soon after you power on the display unit.

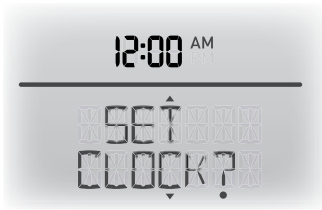

Note: The "ק" stays in Selectable Categories, even after setup.



Set the Time

1. Press the "▲" or "▼" buttons until "SET CLOCK?" is displayed on the Selectable Category part of the display unit.
2. Press the "SET" button to set the clock.
3. Press the "▲" or "▼" buttons to adjust the hour. Note the "AM" and "PM" indicators.
4. Press the "SET" button to confirm hour selection.
5. Press the "▲" or "▼" buttons to adjust minutes.
6. Press the "SET" button to confirm minute selection.

The clock is now set.

Set the Date

1. Press the "▲" or "▼" buttons until "SET DATE?" is displayed on the Selectable Category part of the display unit.
2. Press the "SET" button to set the date.
3. Press the "▲" or "▼" buttons to adjust the month.
4. Press the "SET" button to confirm month selection.
5. Press the "▲" or "▼" buttons to adjust the day.
6. Press the "SET" button to confirm day selection.
7. Press the "▲" or "▼" buttons to adjust the year.
8. Press the "SET" button to confirm year selection.

The date is now set.

Select Measurement Units

To select between standard units (mph, °F, etc.) or metric units (kph, °C, etc.):

1. Press the "▲" or "▼" buttons until "SET UNITS?" is displayed on the Selectable Category part of the display unit.
2. Press the "SET" button to set the unit preference.
3. Press the "▲" or "▼" buttons to select "STAND" for standard or "METRIC" for metric units.
4. Press the "SET" button to confirm your selection.
5. Next, you will see "WIND MPH". Press the "▲" or "▼" buttons to select MPH, KPH, or KNOTS for wind speed units.
6. Press the "SET" button to confirm your selection.

Units are now set.



Placement for Maximum Accuracy

AcuRite sensors are sensitive to surrounding environmental conditions. Proper placement of both the display unit and the sensor are critical to the accuracy and performance of this product.



Display Unit Placement

Place the display unit in a dry area free of dirt and dust. To ensure accurate temperature measurement, place out of direct sunlight and away from heat sources or vents. Display unit stands upright for tabletop use or is wall-mountable.



5-in-1 Sensor Placement

The 5-in-1 sensor is designed to remain outdoors all year long. Choose an open location with no obstructions above or around the sensor for the most accurate measurements.

Important Placement Guidelines

Display unit and sensor must be within 330 feet (100 m) of each other.

MAXIMIZE WIRELESS RANGE

Place units away from large metallic items, thick walls, metal surfaces, or other objects that may limit wireless communication.

PREVENT WIRELESS INTERFERENCE

Place both units at least 3 feet (.9 m) away from electronic devices (TV, computer, microwave, radio, etc.).

LOCATE AWAY FROM HEAT SOURCES

Position sensor away from heaters, air conditioners, chimneys, exhaust vents, asphalt and concrete (surfaces that radiate heat).

LOCATE AWAY FROM HUMIDITY SOURCES

Avoid installing the sensor near pools, spas, or other bodies of water. Water sources may impact humidity accuracy.

LOCATE AWAY FROM SPRINKLER HEADS

DO NOT install the sensor where it will be sprayed by a sprinkler system. This may force water inside the sensor.

LOCATE AWAY FROM WIND & RAIN OBSTRUCTIONS

DO NOT mount the sensor with obstructions around it. Consider a location that is a wide open area, with few structures around to ensure accurate wind measurement.

Visit us online to view installation photos and video, or learn more about AcuRite technology:

www.AcuRite.com/5in1



View Video

5-in-1 Sensor Installation Guidelines

INSTALLATION HEIGHT Mount the sensor at a minimum height of 5 feet (1.5 meters) off the ground, in an open area. Higher is better for wind measurements- the National Weather Service recommends 33 feet (10 meters) high!

MOUNTING OPTIONS The included mounting bracket is designed to screw directly onto wooden posts or surfaces that are 2"x4" or larger. The sensor can also be mounted directly to a 3/4" steel pipe.

SOLAR CELL INSTALLATION Install the sensor with the **solar cell facing SOUTH**. This ensures the cell receives as much sun as possible and orients wind direction.

5-in-1 Sensor Installation

1. Fasten mounting base (included) to a post or pole (not included) using the 4 longer screws included in the hardware bag.
2. Insert the mounting base into the hole on the bottom of the sensor.
3. Make sure the arrows on the top of the sensor are pointed in the proper direction and the bubble level is centered. The solar cell should be facing south to properly orient the wind direction.
4. Fasten the sensor into the mounting base using the 2 shorter screws included in the hardware bag.

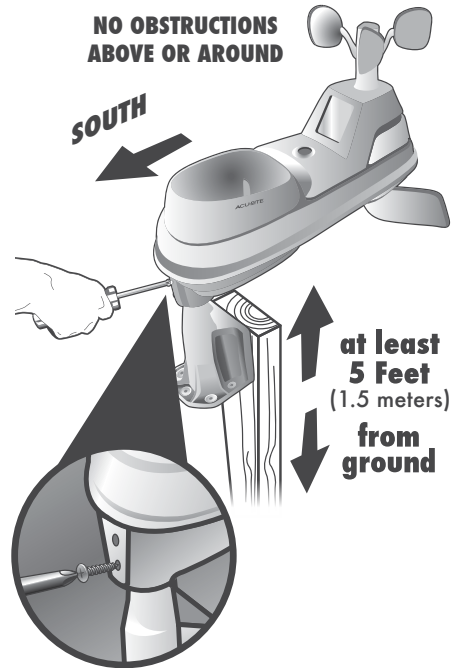

The 5-in-1 sensor is now ready to use.

5-in-1 Sensor Installation Guidelines

Clear Data Collected During Installation

When installation is complete, clear erroneous data from the display unit by pressing the "CLEAR TODAY" button, on the back of the display inside the battery compartment. This button will clear data recorded since 12:00 am.

Basic Setup is Complete

The 5-in-1 sensor will now synchronize with the display unit. It may take a few minutes for synchronization to complete. If both or one of the units appear to be functioning improperly, please refer to the troubleshooting section.

Using the Professional Weather Center

Learning Mode

Self-Calibrating Forecasting use a unique algorithm to analyze changes in pressure over a time period (called Learning Mode) to determine your altitude. After 14 days, the Learning Mode icon disappears from the display screen. At this point, the self-calibrated pressure is tuned in to your location and the unit is ready for superior weather prediction.

Weather Forecast

AcuRite's patented Self-Calibrating Forecasting provides your personal forecast of weather conditions for the next 12 to 24 hours by collecting data from the sensor in your backyard. It generates a forecast with pinpoint accuracy - personalized for your exact location.

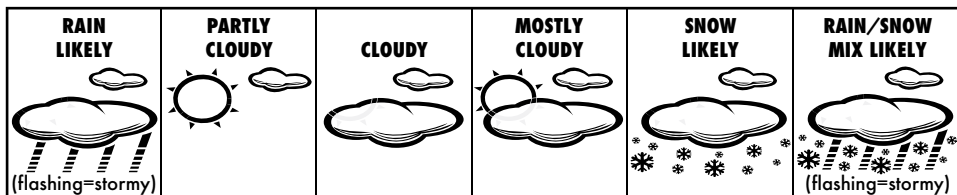

View the complete list of icons at www.AcuRite.com/acurite-icons

Weather Select

The Weather Select area on the display includes the following weather data and calculations: heat index, dew point, wind chill, indoor temperature and humidity, and rainfall rate (inches/hour). To toggle between Weather Select categories, press the "▶" button, located left of the Weather Select display area.

Rainfall Event

The rainfall feature tracks rain accumulation over all-time, the current month, and current rainfall event. Current event clears when no rain registers for 8 hours OR no rain registers for 1 hour and pressure rises by .03inhg or more.

Barometric Pressure

Subtle variations in barometric pressure greatly affect the weather. This weather center displays the current pressure with an arrow icon to indicate the direction the pressure is trending (FALLING, STEADY, or RISING).

Weather Ticker™

The Weather Ticker™ automatically streams your real-time weather information and alerts as scrolling text in the lower part of the display unit screen.

You can manually cycle through all the available messages by pressing "SET".

Default WEATHER TICKER messages are pre-loaded as follows:

FORECAST	12 to 24 hour future weather forecast
MOON PHASE	Current moon phase
INDOOR COMFORT	Dry, OK or humid comfort level
IT FEELS LIKE ___ OUTSIDE	Calculates what temperature it feels like outdoors (based on temperature, humidity and wind speed)
OUTDOOR TEMP THIS WEEK HIGH	Highest temperature recorded this calendar week
OUTDOOR TEMP THIS WEEK LOW	Lowest temperature recorded this calendar week
OUTDOOR TEMP THIS MONTH HIGH	Highest temperature recorded this calendar month
OUTDOOR TEMP THIS MONTH LOW	Lowest temperature recorded this calendar month

Additional Messages Include:

NEW HIGH TEMPERATURE RECORD

NEW LOW TEMPERATURE RECORD

NEW WIND SPEED RECORD TODAY

CURRENT RAINFALL RATE

CURRENT RAIN EVENT STARTED

NO RAIN RECORDED SINCE ____

WEATHER ALARM MESSAGES

SENSOR BATTERIES LOW

SENSOR SIGNAL LOST

Adjust the Weather Ticker Speed

1. Press the "▲" or "▼" buttons until "TICKER SPEED" is displayed on the Selectable Category part of the display unit.
2. Press the "SET" button to set the speed preference.
3. Press the "▲" or "▼" buttons to select a speed: SLOW, NORMAL, or FAST.
4. Press the "SET" button to confirm your selection.

Weather Ticker speed is now set.

Customize Weather Ticker Messages

Customize which messages you want to scroll across the WEATHER TICKER:

1. Press the "↻" button to manually cycle through each message available.
2. During the MANUAL REVIEW: PRESS the "add ✓" button to activate the current scrolling message. The corresponding "add ✓" appears on screen to the left of the message to indicate the message is now active in the ticker cycle. PRESS the "X remove" button to deactivate the current scrolling message. The corresponding "X remove" appears on screen to the left of the message to indicate the message is now deactivated from the ticker cycle.

Please note: Messages can only be added and removed to the ticker cycle during manual review. The "add ✓" and "X remove" buttons do not add or remove messages during the automatic cycle.

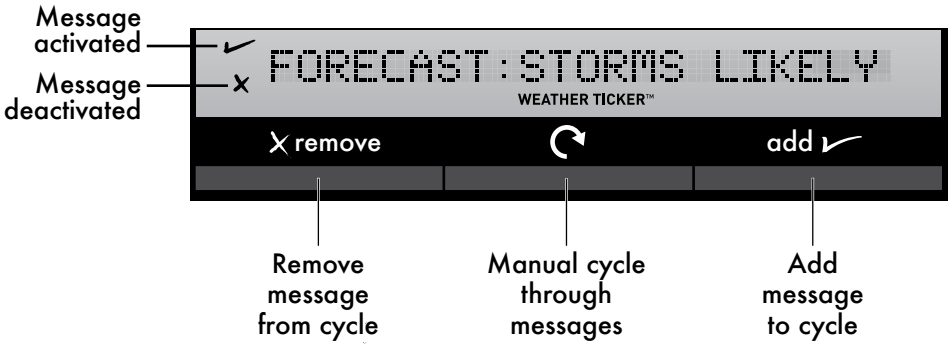

Programmable Weather Alarms

Each Selectable Weather Category features an alarm option. When an alarm sounds, the display unit emits audible beeping and flashes the affected category, its alarm settings, and any other relevant data.

Some alarms can be customized to alert you when your programmed value is reached. Alarms include:

OUTDOOR HUMIDITY	LOW	HIGH
OUTDOOR TEMP	LOW	HIGH
STORM ALARM	HIGH	
INDOOR HUMIDITY	LOW	HIGH
INDOOR TEMP	LOW	HIGH
WIND CHILL	LOW	
DEW POINT	LOW	HIGH
HEAT INDEX	HIGH	
RAIN	HIGH	
WIND SPEED	HIGH	

The rain alarm does not require a preset numerical value, but instead sounds as soon as rain is recorded. Similarly, the storm alarm sounds when a large atmospheric pressure drop occurs, which usually indicates an oncoming storm. Note: The storm alarm is NOT intended to be a safety device or warning system.



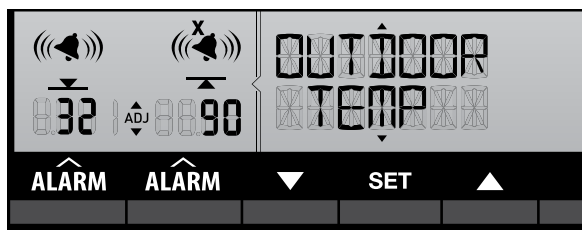

Set a Weather Alarm

1. Choose the weather category for which you wish to set an alarm by pressing the "▲" or "▼" buttons until the category is displayed on the Selectable Category part of the display unit.
2. To program a value (only applies to alarms that require a value), press AND HOLD the "((◀))" button underneath the alarm you wish to set until the "ADJ" indicator appears and the alarm setting flashes.
3. Adjust the alarm value by pressing the "▲" or "▼" buttons.
4. Press the "((◀))" button to confirm a value.
5. Next, press the "((◀))" button to activate the alarm (the X indicator disappears when alarm is activated).



Alarm is now programmed and turned on.



ICON DEFINITIONS

-  = Alarm On
-  = Alarm Off
-  = Adjust Mode
-  = Low Value
-  = High Value

BUTTON FUNCTIONS

-  Press to activate or deactivate an alarm.
- ALARM**  Press and hold to set or adjust an alarm value.

Silence a Sounding Alarm

The alarm sounds initially for a few minutes, then silences itself. The alarm then sounds every few minutes afterwards until one of the following happens:

1. "SNOOZE" - Press any button. Alarm silences, but sounds again if the alarm condition reoccurs.
2. Turn alarm "OFF" - Deactivates alarm.

Troubleshooting

Problem	Possible Solution
<p>No outdoor sensor reception</p>  no bars	<ul style="list-style-type: none"> • Relocate the display unit and/or the 5-in-1 sensor. The units must be within 330 ft (100 m) of each other. • Make sure both units are placed at least 3 feet (.9 m) away from electronics that may interfere with the wireless communication (such as TVs, microwaves, computers, etc). • Use standard alkaline batteries (or lithium batteries in sensor when temperature is below -4°F/-20°C). Do not use heavy duty or rechargeable batteries. NOTE: It may take up to 20 minutes for display unit and sensor to synchronize after batteries are replaced. • Synchronize the units: <ol style="list-style-type: none"> 1. Bring both the sensor and display unit indoors and remove batteries from each. 2. Reinstall batteries in outdoor sensor. 3. Reinstall batteries in display unit. 4. Let the units sit within a couple feet of each other for about 20 minutes to gain a strong connection.
<p>Outdoor temperature is flashing or showing dashes</p>	<p>Flashing of the outdoor temperature may be an indication of wireless interference.</p> <ul style="list-style-type: none"> • Make sure the A-B-C switch in the battery compartments of both the display unit and sensor are switched to the same letter. You may choose A, B or C; but both units must match to sync up. Sometimes changing to a different channel can help.
<p>Weather Ticker Hard to Read</p>	<ul style="list-style-type: none"> • Slow down the speed of the ticker (see page 14).
<p>Inaccurate forecast</p>	<ul style="list-style-type: none"> • Weather Forecast icon predicts conditions for the next 12 to 24 hours, not current conditions. • Has Learning Mode icon disappeared from the display unit? Learning Mode must complete before forecast and pressure will be accurate. • Allow unit to run continuously for 33 days. Battery removal or resetting the display unit will restart Learning Mode. After 14 days, forecast should be fairly accurate, however Learning Mode calibrates for a total of 33 days.

Troubleshooting

Problem	Possible Solution
<p>Inaccurate temperature or humidity</p>	<ul style="list-style-type: none"> • Make sure both the display unit and 5-in-1 sensor are placed away from any heat sources or vents (see page 11). • Make sure both units are positioned away from moisture sources (see page 11). • Make sure 5-in-1 sensor is mounted at least 5 ft off of the ground. • Calibrate indoor and outdoor temperature and humidity (see page 20).
<p>No rainfall</p>	<ul style="list-style-type: none"> • Check to ensure the rain gauge stabilizer (plastic tab) has been removed from the bottom of the sensor (see page 7). • Clear debris, such as leaves, out of the rain collector funnel and debris screen. • Calibrate the Rain Gauge (see page 21).
<p>Inaccurate wind readings</p>	<ul style="list-style-type: none"> • What is wind reading being compared to? Pro weather stations are typically mounted at 30 ft high or more. Make sure to compare data using a sensor positioned at the same mounting height. • Check location of the sensor. Ensure it's mounted a minimum of 5 ft in the air with no obstructions around it (within several feet). • Ensure wind cups are spinning freely. If they hesitate or stop try lubricating with graphite powder or spray lubricant.
<p>Display screen not working</p>	<ul style="list-style-type: none"> • Check that the batteries are installed correctly. Batteries may need to be replaced. • Reset the display by pressing the reset button, located on the back of the display unit. Date and time will need to be entered after a reset.

If your AcuRite product does not operate properly after trying the troubleshooting steps, visit www.AcuRite.com or call (877) 221-1252 for assistance.

Care & Maintenance

Display Unit Care

Clean with a soft, damp cloth. Do not use caustic cleaners or abrasives. Keep away from dust, dirt and moisture. Clean ventilation ports regularly with a gentle puff of air.

5-in-1 Sensor Care

Clean the Sensor

Clean with a soft damp cloth. Do not use caustic cleaners or abrasives that will mar the polished surfaces of the rain collection funnel or the solar cell. Scratches will result in decreased performance and reliability.

Insect Prevention

Insects may cause obstructions and interrupt data by nesting in or on the 5-in-1 sensor. To limit this problem, spray sensor with a household insect repellent. Consult the insect repellent instructions prior to use.

Snow & Freezing Weather

The 5-in-1 sensor will not be damaged by freezing conditions. NOTE: If the rain collector cup fills with snow and then melts, it will register as rain on the display unit.

Clean the Rain Collector Cup

Remove and empty rain collector debris filter. The debris filter is located in the rain collector funnel. Remove from the top by gently squeezing and pulling out.

Clean the Wind Vane & Anemometer

Remove foreign matter from the outside of the sensor for free movement of the wind vane and anemometer. If needed, use a small amount of spray lubricant, clear silicone or graphite powder on the anemometer for improved movement.

Calibration

Calibrate Temperature & Humidity

The indoor / outdoor temperature and humidity readings can be calibrated on the display unit to improve accuracy. Calibration improves accuracy when 5-in-1 sensor placement or environmental factors impact your data accuracy.

1. Choose the weather category you wish to calibrate by pressing the "▲" or "▼" buttons until the category is displayed on the Selectable Category part of the display unit.
2. Press AND HOLD the "▲" and "▼" buttons and the "SET" button all at the same time for 15-20 seconds.
 - The display unit beeps, and all display data is hidden except for the value being calibrated.
 - "▲_{ADJ}" (calibrate) and arrows appear next to the value being calibrated.

3. Press the "▲" or "▼" buttons to calibrate the data value higher or lower from the actual reading.
4. Press the "SET" button to confirm the calibration adjustment. Note: The "▲_{ADJ}" icon remains illuminated next to calibrated values.



Calibrate the Rain Gauge

The rain gauge on the 5-in-1 sensor can be calibrated to improve accuracy.

Items Needed: 5-in-1 sensor, display unit, plastic cup, pin, screw driver

1. First, ensure 5-in-1 sensor is perfectly level using built-in bubble level.
2. Place display unit close so you can monitor it during calibration.
3. Make a pin hole in the bottom of a plastic cup. Hold the cup over the rain gauge and fill it with exactly 1 cup (8oz) of water, allowing the water to drip into the rain gauge. You should hear the internal buckets tip and see water drain through the rain gauge.
4. A few seconds after each bucket tip, the display unit displays rainfall in approximately 0.01" (.254 mm) or more increments.
5. The cup of water should take more than 20 minutes to empty; a quicker period will result in inaccurate calibration. Try to simulate a normal steady rainfall. When cup is empty of water, display unit should register 1.06" (26.924 mm)

Tips

- There should be nearly an equal number of water drops (about 25 water drops) between bucket tips. If not, adjust the calibration screws on the bottom of the 5-in-1 sensor until an equal number of water drops are tipping the buckets. Then, restart the calibration procedure.
- If you don't hear the buckets tipping and see water dripping alternately out of each drain, there may be an issue with the rain gauge or it's adjustment. See Troubleshooting on page 19.

Adjustment

If the rain gauge doesn't register close to 1.06" (26.924 mm), make an EQUAL adjustment to the two calibration screws on the bottom of the 5-in-1 sensor. Turning screws clockwise increases rainfall; counter clockwise decreases rainfall.

- To adjust the rainfall reading by 2% turn both screws 1/8 of a turn.
- To adjust the rainfall reading by 4% turn both screws 1/4 of a turn.
- To adjust the rainfall reading by 8% turn both screws 1/2 of a turn.

Watch the video at www.acurite.com/5n1

Specifications

TEMPERATURE RANGE	Outdoor: -40°F to 158°F; -40°C to 70°C
	Indoor: 32°F to 122°F; 0°C to 50°C
HUMIDITY RANGE	Outdoor: 1% to 99%
	Indoor: 16% to 98%
WIND SPEED	0 to 99 mph; 0 to 159 kph
WIND DIRECTION INDICATORS	16 points
RAINFALL	0 to 99.99 in; 0 to 9999 mm
WIRELESS RANGE	330ft / 100m depending on home construction materials
OPERATING FREQUENCY	433 MHz
POWER	Display: 4.5 vdc, 250mA power adapter 6 x AA alkaline batteries (optional) Sensor: 4 x AA alkaline or lithium batteries
DATA REPORTING	Wind Speed: 18 second updates; Direction: 30 seconds Outdoor temperature & humidity: 36 second updates Indoor temperature & humidity: 60 second updates

FCC Information

This device complies with part 15 of FCC rules. Operation is subject to the following two conditions:

1- This device may NOT cause harmful interference, and

2- This device must accept any interference received, including interference that may cause undesired operation.

This equipment has been tested and found to comply with the limits for a Class B digital device, pursuant to Part 15 of the FCC rules. These limits are designed to provide reasonable protection against harmful interference in a residential installation. This equipment generates, uses and can radiate radio frequency energy and, if not installed and used in accordance with the instructions, may cause harmful interference to radio communications. However, there is no guarantee that interference will not occur in a particular installation. If this equipment does cause harmful interference to radio or television reception, which can be determined by turning the equipment off and on, the user is encouraged to try to correct the interference by one or more of the following measures:

- Reorient or relocate the receiving antenna.
- Increase the separation between the equipment and the receiver.
- Connect the equipment into an outlet on a circuit different from that to which the receiver is connected.
- Consult the dealer or an experienced radio/TV technician for help.

NOTE: The manufacturer is not responsible for any radio or TV interference caused by unauthorized modifications to this equipment. Such modifications could void the user authority to operate the equipment.

This device complies with Industry Canada licence-exempt RSS standard(s).

Operation is subject to the following two conditions:

(1) This device may not cause interference, and

(2) This device must accept any interference received, including interference that may cause undesired operation of the device.

Customer Support

AcuRite customer support is committed to providing you with best-in-class service. **For assistance**, please have the model number of this product available and contact us in any of the following ways:



(877) 221-1252



info@chaney-inst.com

24/7 support at www.AcuRite.com

- ▶ Installation Videos
- ▶ Register your Product
- ▶ Instruction Manuals
- ▶ Support User Forum
- ▶ Replacement Parts
- ▶ Submit Feedback & Ideas

IMPORTANT

PRODUCT MUST BE REGISTERED
TO RECEIVE WARRANTY SERVICE

PRODUCT REGISTRATION

Register online
to receive 1 year
warranty protection

www.AcuRite.com

FOR NOW

SUPPORT

Support Forum

Archived Products

▶ Register a Product

Limited One Year Warranty

At AcuRite, we proudly uphold our commitment to quality technology. Chaney Instrument Co. warrants that all products it manufactures to be of good material and workmanship, and to be free of defects when properly installed and operated for a period of one year from the date of purchase.

We recommend that you visit us at www.AcuRite.com for the fastest way to register your product. However, product registration does not eliminate the need to retain your original proof of purchase in order to obtain warranty benefits.

Chaney Instrument Co. warrants that all products it manufactures to be of good material and workmanship, and to be free of defects when properly installed and operated for a period of one year from the date of purchase. Remedy for breach of this warranty is limited to repair or replacement of the defective item(s). Any product which, under normal use and service, is proven to breach the warranty contained herein within ONE YEAR from date of sale will, upon examination by Chaney, and at its sole option, be repaired or replaced by Chaney. Transportation costs and charges for returned goods shall be paid for by the purchaser. Chaney hereby disclaims all responsibility for such transportation costs and charges. This warranty will

not be breached, and Chaney will give no credit for products it manufactures which have received normal wear and tear, been damaged (including by acts of nature), tampered, abused, improperly installed, damaged in shipping, or repaired or altered by others than authorized representatives of Chaney.

The above-described warranty is expressly in lieu of all other warranties, express or implied, and all other warranties are hereby expressly disclaimed, including without limitation the implied warranty of merchantability and the implied warranty of fitness for a particular purpose. Chaney expressly disclaims all liability for special, consequential or incidental damages, whether arising in tort or by contract from any breach of this warranty. Some states do not allow the exclusion or limitation of incidental or consequential damages, so the above limitation or exclusion may not apply to you. Chaney further disclaims all liability from personal injury relating to its products to the extent permitted by law. By acceptance of any of Chaney's products, the purchaser assumes all liability for the consequences arising from their use or misuse. No person, firm or corporation is authorized to assume for Chaney any other liability in connection with the sale of its products. Furthermore, no person, firm or corporation is authorized to modify or waive the terms of this paragraph, and the preceding paragraph, unless done in writing and signed by a duly authorized agent of Chaney. This warranty gives you specific legal rights, and you may also have other rights which vary from state to state.

For in-warranty claims:
Chaney Instrument Co. | 965 Wells St. | Lake Geneva, WI 53147

ACU>RITE®



Weather
Stations



Temperature
& Humidity



Weather
Alert Radio



Kitchen
Thermometers
& Timers



Clocks

It's More than Accurate, it's ACU>RITE.

AcuRite offers an extensive assortment of precision instruments, designed to provide you with information you can depend on to Plan your day with confidence™.

www.AcuRite.com

©Chaney Instrument Co. All rights reserved. AcuRite is a registered trademark of the Chaney Instrument Co., Lake Geneva, WI 53147. All other trademarks and copyrights are the property of their respective owners. AcuRite uses patented technology. Visit www.AcuRite.com/patents for details.