

Professional Weather Center

model 01141



CONTENTS

Unpacking Instructions	2	5-in-1 Sensor Installation.....	11
Package Contents	2	Using the Weather Center	12
Product Registration	2	Programmable Alarms.....	13
Features & Benefits: 5-in-1	3	Troubleshooting	14
Features & Benefits: Display....	4	Care & Maintenance.....	16
Setup	7	Calibrate the Rain Gauge.....	17
5-in-1 Sensor Setup	7	Specifications.....	18
Display Setup	8	FCC Information	18
Set the Time, Date & Units	9	Customer Support	19
Backlight Settings.....	9	Warranty.....	19
Placement Guidelines	10		

Questions? Contact Customer Support at (262) 729-4852 or visit www.AcuRite.com.

SAVE THIS MANUAL FOR FUTURE REFERENCE.



Congratulations on your new AcuRite product. To ensure the best possible product performance, please read this manual in its entirety and retain it for future reference.

Unpacking Instructions

Remove the protective film that is applied to the LCD screen prior to using this product. Locate the tab and peel off to remove.

Package Contents

1. Display with Tabletop Stand
2. 5-in-1 Sensor
3. Sensor Mounting Bracket
4. Mounting Hardware
5. Power Adapter
6. Instruction Manual

IMPORTANT

PRODUCT MUST BE REGISTERED
TO RECEIVE WARRANTY SERVICE

PRODUCT REGISTRATION

Register online to receive 1 year warranty protection

www.AcuRite.com

Features & Benefits

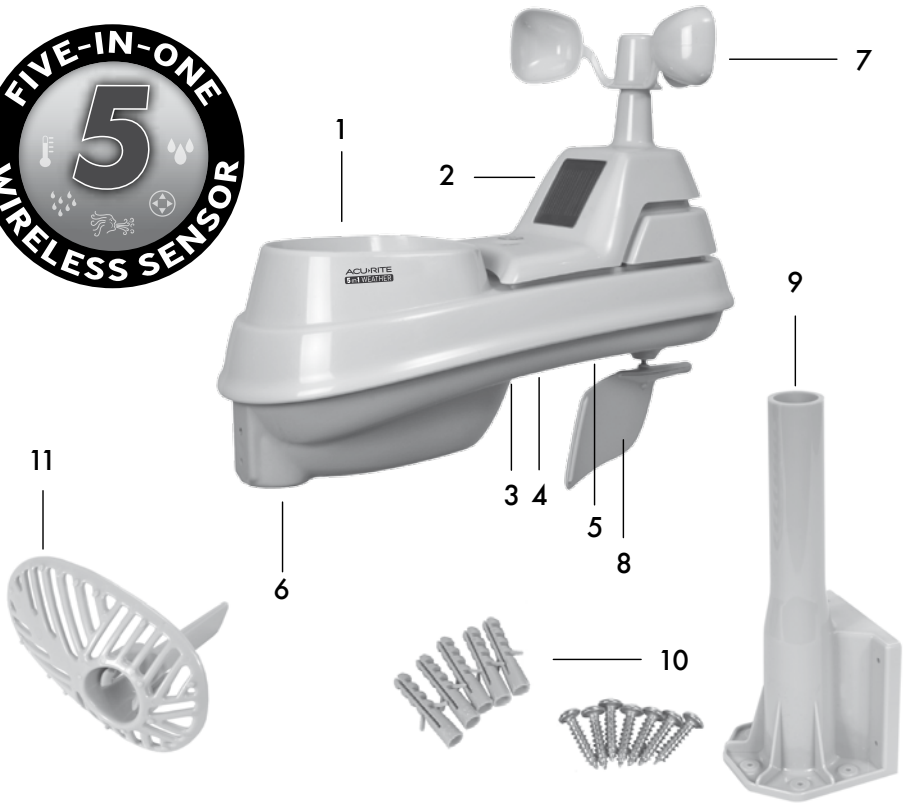

5-in-1 SENSOR

- 1. Rainfall Collector Funnel**
- 2. Solar Cell Panel**
Converts sunlight into power to run internal aspirating fan.
Internal Aspirating Fan
(not shown)
Draws ambient air into sensor to reduce solar radiation heating, resulting in more accurate temperature measurement.
- 3. A-B-C Switch**
ID code that must match display's A-B-C switch to ensure units synchronize.
- 4. Battery Compartment**

- 5. Temperature & Humidity Sensors**
(internal)
- 6. Mounting Point**
- 7. Wind Speed Anemometer**
- 8. Wind Direction Vane**
- 9. Mounting Bracket**
- 10. Mounting Hardware**
Includes 5 anchors and the following screws:

Qty	Diameter	Length
5	#4	3/4"
1	#4	1/2"
1	#6	1/2"

- 11. Debris Filter**
Pre-installed to prevent debris from entering the rain gauge.

Features & Benefits

Display

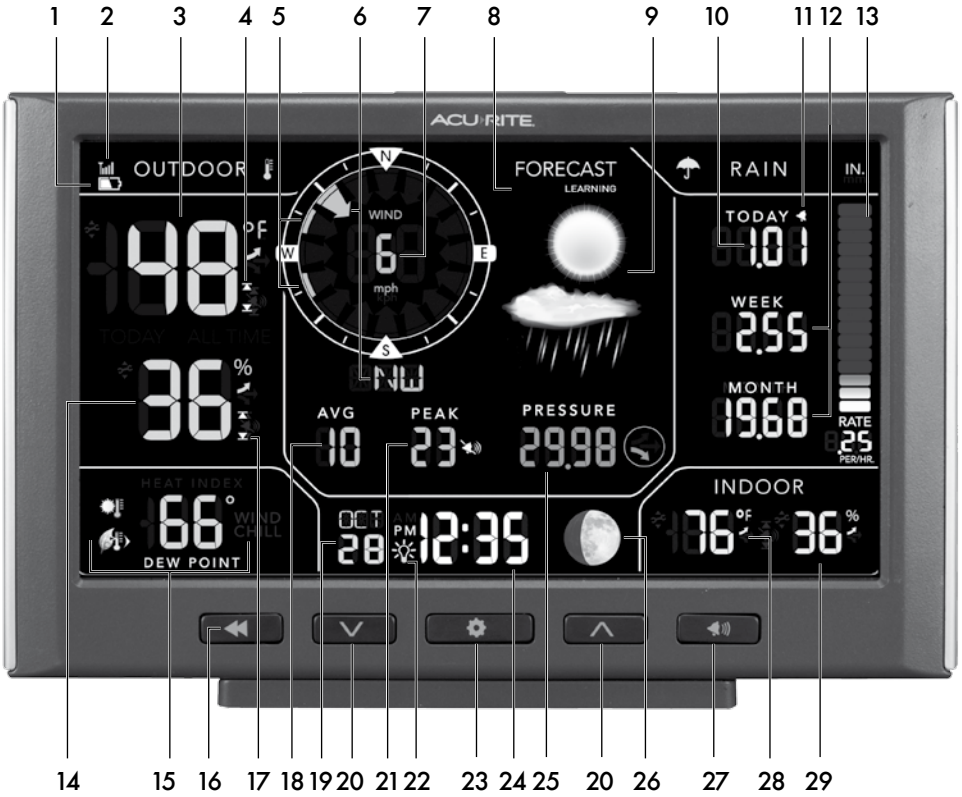

DISPLAY FRONT

- 1. Sensor Low Battery Indicator**
- 2. Outdoor Sensor Signal Strength**
- 3. Current Outdoor Temperature**
Arrow icon indicates direction the temperature is trending.
- 4. ▲ Icon**
Indicates high records are being viewed.
- 5. Previous 2 Wind Directions**
- 6. Current Wind Direction**
- 7. Current Wind Speed**
- 8. Learning Mode Icon**
Disappears after weather forecast self-calibration is complete (see page 12).
- 9. 12 to 24 Hour Weather Forecast**
Self-Calibrating Forecasting pulls data from outdoor sensor to generate your personal forecast.
- 10. Current Rainfall**
Rainfall recorded since 12:00 am.
- 11. 📞 Icon**
Indicates an alarm value has been activated.
- 12. Previous Rainfall Data**
- 13. Rainfall Rate**
Only applies to current rainfall data.
- 14. Current Outdoor Humidity**
Arrow icon indicates the direction the humidity is trending.
- 15. Seasonal Display**
Heat Index calculation displays when temperature is 80°F (27°C) or higher. Dew Point calculation displays when temperature is 79°F (26°C) or below. Wind chill calculation displays when temperature is 40°F (4°C) or lower.
- 16. ⏪ Button**
For viewing all-time high and low records.
- 17. ▼ Icon**
Indicates low records are being viewed.
- 18. Average Wind Speed**
Average of all speeds over the past 2 minutes.
- 19. Date**
- 20. ▼ and ▲ Buttons**
For setup preferences and viewing today's high & low records.
- 21. Peak Wind Speed**
Highest speed from past 60 minutes.
- 22. 💡 Icon**
Indicates display is in auto-dimming brightness mode (see page 9).
- 23. ⚙️ Button**
For setup preferences.
- 24. Clock**
- 25. Current Barometric Pressure**
Arrow icon indicates the direction the pressure is trending.
- 26. Moon Phase**
- 27. 📞 Button**
For alarm setup.
- 28. Current Indoor Temperature**
Arrow icon indicates the direction the temperature is trending.
- 29. Current Indoor Humidity**
Arrow icon indicates the direction the humidity is trending.

Features & Benefits



DISPLAY BACK

- 1. Backlight Button**
For momentary backlight and dimmer settings.
- 2. Integrated Hang Holes**
For easy wall mounting.
- 3. Backup Battery Compartment**
- 4. A-B-C Switch**
ID code that must match sensor's A-B-C switch to ensure units synchronize.
- 5. Plug-in for Power Adapter**
- 6. Battery Compartment Cover**
- 7. Power Adapter**
- 8. RESET Button**
Press and release to clear historical record. Press and hold for 10 seconds for full reset to factory defaults.

5-in-1 Sensor Setup

1 Set the A-B-C Switch

Locate the A-B-C switch inside the battery compartment. Set the A-B-C switch to A, B or C. You must select the same letter choices for both the sensor and the display in order for the units to synchronize.

2 Install or Replace Batteries

Batteries **MUST** be installed for this product to operate. AcuRite recommends high quality alkaline or lithium batteries for the best product performance. Heavy duty or rechargeable batteries are not recommended.

The 5-in-1 sensor requires lithium batteries in low temperature conditions. Cold temperatures can cause alkaline batteries to function

improperly. Use lithium batteries in the 5-in-1 sensor for temperatures below $-4^{\circ}\text{F}/-20^{\circ}\text{C}$.

1. Slide off the battery compartment cover.
2. Insert 4 x AA batteries into the battery compartment, as shown. Follow the polarity (+/-) diagram in the battery compartment.
3. Replace the battery cover.

3 Remove Rain Gauge Stabilizer

Locate and remove the rain gauge stabilizer (plastic tab) taped into the bottom of the sensor. The rain gauge will not function until this is removed.

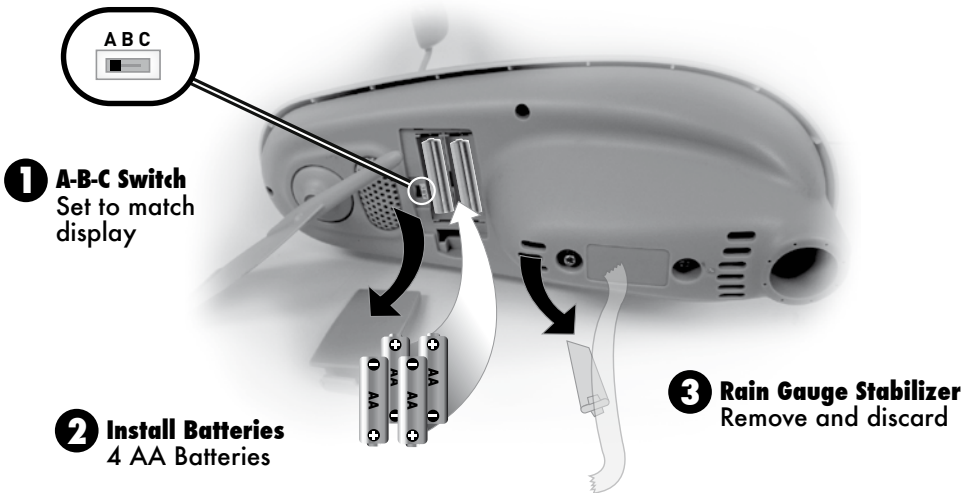

LITHIUM BATTERIES -40°F (-40°C) (70°C) 158°F

ALKALINE BATTERIES -4°F (-20°C) (70°C) 158°F

Display Setup

1 Set the A-B-C Switch

The A-B-C switch is located inside the battery compartment. It can be set to A, B or C. However, you must select the same letter choices for both the 5-in-1 Sensor and the display in order for the units to synchronize.

3 Install or Replace Backup Batteries (optional)

Insert 3 x AAA alkaline batteries into the battery compartment, as shown. Follow the polarity (+/-) diagram in the battery compartment.

2 Plug Power Adapter into Electric Outlet

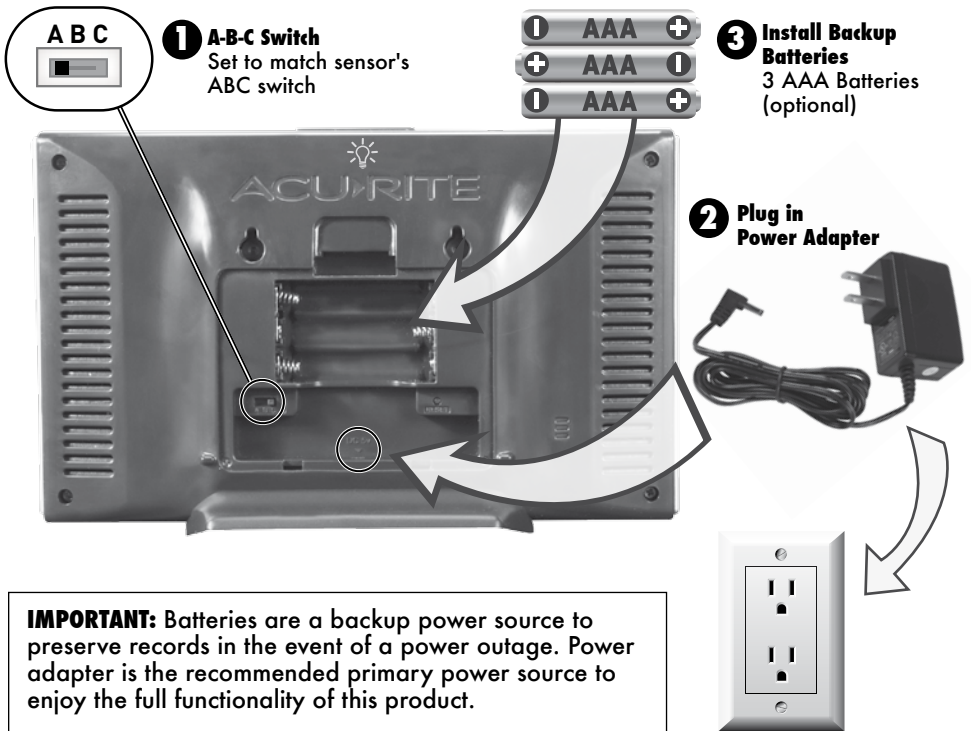

PLEASE DISPOSE OF OLD OR DEFECTIVE BATTERIES IN AN ENVIRONMENTALLY SAFE WAY AND IN ACCORDANCE WITH YOUR LOCAL LAWS AND REGULATIONS.

BATTERY SAFETY: Clean the battery contacts and also those of the device prior to battery installation. Remove batteries from equipment which is not to be used for an extended period of time. Follow the polarity (+/-) diagram in the battery compartment. Promptly remove dead batteries from the device. Dispose of used batteries properly. Only batteries of the same or equivalent type as recommended are to be used. DO NOT incinerate used batteries. DO NOT dispose of batteries in fire, as batteries may explode or leak. DO NOT mix old and new batteries or types of batteries (alkaline/standard). DO NOT use rechargeable batteries. DO NOT recharge non-rechargeable batteries. DO NOT short-circuit the supply terminals.

Set the Time, Date & Units

Press the “⚙️” button, located on the front of the display, to enter SET MODE. Once in set mode, the preference you are currently setting will blink on the display.

To adjust the currently selected (flashing) item, press and release the “^” or “v” buttons (press and HOLD to fast adjust).

To save your adjustments, press and release the “⚙️” button again to adjust the next preference. The preference set order is as follows:

CLOCK HOUR

CLOCK MINUTE

CALENDAR MONTH

CALENDAR DATE

CALENDAR YEAR

TEMPERATURE UNITS (°F or °C)

WIND SPEED UNITS (mph, km/h, knots)

RAINFALL UNITS (inches or mm)

PRESSURE UNITS (inHg or hPa)

You will automatically exit SET MODE if no buttons are pressed for 20 seconds. Enter setup mode at any time by pressing the “⚙️” button.

Display Backlight Settings

This weather station’s color display features three different lighting settings: High (100%) brightness, Medium (60%) brightness and Low (15%) brightness. When display is powered with the power adapter, backlight remains on at 100% brightness. Press the “💡” button once to dim to 60% brightness; press again to dim to 15%, press a third time to enter AUTO-DIM mode. “💡” will appear next to the clock.

NOTE: Pressing and holding the “💡” button for 5 seconds will disable the backlight. Once any button is pressed, the backlight will return to your selected setting.

AUTO DIM MODE: Automatically adjusts display brightness based on time of day.
6:00 a.m. - 9:00 p.m. = 100% brightness
9:01 p.m. - 5:59 a.m. = 15% brightness

Placement for Maximum Accuracy

AcuRite sensors are sensitive to surrounding environmental conditions. Proper placement of both the display and the sensor are critical to the accuracy and performance of this product.



Display Placement

Place the display in a dry area free of dirt and dust. To ensure accurate temperature measurement, place out of direct sunlight and away from heat sources or vents. Display stands upright for tabletop use or is wall-mountable.



5-in-1 Sensor Placement

The 5-in-1 sensor is designed to remain outdoors all year long. Choose an open location with no obstructions above or around the sensor for the most accurate measurements.

Important Placement Guidelines

Display and sensor must be within 330 feet (100 m) of each other.

MAXIMIZE WIRELESS RANGE

Place units away from large metallic items, thick walls, metal surfaces, or other objects that may limit wireless communication.

PREVENT WIRELESS INTERFERENCE

Place both units at least 3 feet (.9 m) away from electronic devices (TV, computer, microwave, radio, etc.).

LOCATE AWAY FROM HEAT SOURCES

Position sensor away from heaters, air conditioners, chimneys, exhaust vents, asphalt and concrete (surfaces that radiate heat).

LOCATE AWAY FROM HUMIDITY SOURCES

Avoid installing the sensor near pools, spas, or other bodies of water. Water sources may impact humidity accuracy.

LOCATE AWAY FROM SPRINKLER HEADS

DO NOT install the sensor where it will be sprayed by a sprinkler system. This may force water inside the sensor.

LOCATE AWAY FROM WIND & RAIN OBSTRUCTIONS

DO NOT mount the sensor with obstructions around it. Consider a location that is a wide open area, with few structures around to ensure accurate wind measurement.

Visit us online to view installation photos and video, or learn more about AcuRite technology:

www.AcuRite.com/5in1



View Video

5-in-1 Sensor Installation Guidelines

INSTALLATION HEIGHT Mount the sensor at a minimum height of 5 feet (1.5 meters) off the ground, in an open area. Higher is better for wind measurements - The National Weather Service recommends 33 feet (10 meters) high!

MOUNTING OPTIONS The included mounting bracket is designed to screw directly onto wooden posts or surfaces that are 2 x 4 (4.5 cm x 9.5 cm) or larger. The sensor can also be mounted directly to common 3/4" (20 mm) steel pipe.

5-in-1 Sensor Installation

1. Fasten mounting base (included) to a post or pole (not included) using the 4 longer screws included in the hardware bag.
2. Insert the mounting base into the hole on the bottom of the sensor.
3. Make sure the arrows on the top of the sensor are pointed in the proper direction and the bubble level is centered. The solar cell should be facing south to properly orient the wind direction.
4. Fasten the sensor into the mounting base using the 2 shorter screws included in the hardware bag.

The 5-in-1 sensor is now ready to use.

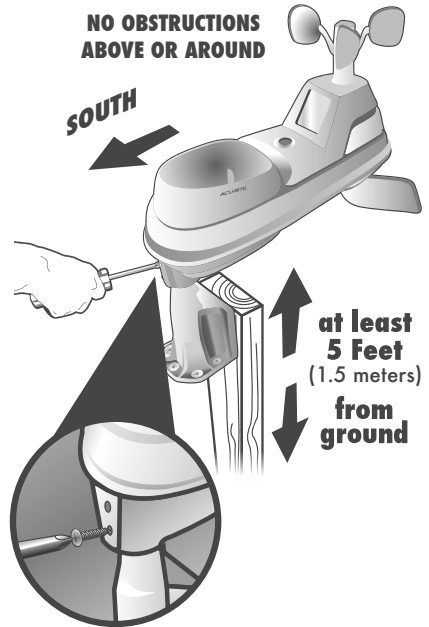

Clear Data Collected During Installation

When installation is complete, press and release the "RESET" button, located on the back of the display inside the battery compartment, to clear erroneous data from the display.

Basic Setup is Complete

The 5-in-1 sensor will now synchronize with the display. It may take a few minutes for synchronization to complete. If both or one of the units appear to be functioning improperly, please refer to the troubleshooting section.

Using the Professional Weather Center

Learning Mode

Self-Calibrating Forecasting use a unique algorithm to analyze changes in pressure over a time period (called Learning Mode) to determine your altitude. After 14 days, the self-calibrated pressure is tuned in to your location and the unit is ready for superior weather prediction.

Weather Forecast

AcuRite's patented Self-Calibrating Forecasting provides your personal forecast of weather conditions for the next 12 to 24 hours by collecting data from the sensor in your backyard. It generates a forecast with pinpoint accuracy - personalized for your exact location.



View the complete list of icons at www.AcuRite.com/acurite-icons

Barometric Pressure

Subtle variations in barometric pressure greatly affect the weather. This weather station displays the current pressure with an arrow icon to indicate the direction the pressure is trending (FALLING, STEADY, or RISING).

Moon Phase

Track the phases of the moon, conveyed through simple lunar phase icons:

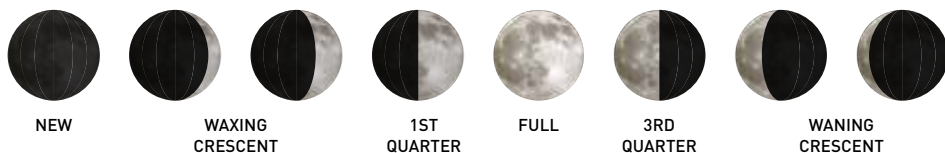

High & Low Records

High and low records for today and all-time are displayed for outdoor temperature and humidity. Rain accumulation data is recorded for today, this week, by month and by year. Today's records automatically clear at 12:00am midnight every day.













Press and release the "◀◀" button to cycle through all historical records. While viewing historical records, a date and timestamp are shown for when each value was recorded. You will automatically exit records if no buttons are pressed for 8 seconds.

To manually clear a HIGH or LOW record, press and release the RESET button, located in the battery compartment, while viewing the record(s) you wish to clear. Dashes display to confirm you have cleared the record(s).







Programmable Alarms

This display features programmable alarms that sound an alert to notify you when a value (for outdoor temperature, humidity, wind speed or rainfall) has been reached or exceeded. When an alarm is triggered, the display emits an audible beep and flashes data in the affected category. You can customize the alarms by turning ON or OFF the alarms you'd like activated or deactivated, and by inputting your own values to trigger the alarm.

Setup an Alarm

1. Press and release the ")" button until the reading for which you wish to set an alarm is shown on the display. "" will be shown.
2. Press and release the "" or "" buttons until ")" appears.
3. Press and release the "" button. The current HIGH alarm value flash on the display.
4. Press and release the "" or "" buttons to adjust the alarm's HIGH value.
5. Press and release the ")" button. If applicable, the current LOW alarm value will be shown on the display.
6. Press and release the "" button and then press and release the "" or "" buttons to adjust the alarm's LOW value.
7. Press and release the ")" button to cycle to the next reading.

Disable an Alarm

1. Press and release the ")" button until the reading for which you wish to disable an alarm is shown on the display. ")" will be shown.
2. Press and release the "" or "" buttons until "" appears.
3. Press and release the ")" button to cycle to the next reading.
4. Repeat steps 1-3, as needed.

NOTE: To disable ALL alarms at once, press and HOLD the ")" button for 10 seconds.

You will automatically exit alarm SET MODE if no buttons are pressed for 10 seconds. Enter alarm SET MODE at any time by pressing the ")" button.

Troubleshooting

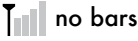
Problem	Possible Solution
<p>No outdoor sensor reception</p> 	<ul style="list-style-type: none"> • Relocate the display and/or the 5-in-1 sensor. The units must be within 330 ft (100 m) of each other. • Make sure both units are placed at least 3 feet (.9 m) away from electronics that may interfere with the wireless communication (such as TVs, microwaves, computers, etc). • Use standard alkaline batteries (or lithium batteries in sensor when temperature is below -4°F/-20°C). Do not use heavy duty or rechargeable batteries. NOTE: It may take a few minutes for display and sensor to synchronize after batteries are replaced. • Synchronize the units: <ol style="list-style-type: none"> 1. Bring both the sensor and display indoors and remove batteries/power adapter from each. 2. Reinstall batteries in outdoor sensor. 3. Reinstall batteries/power adapter in display. 4. Let the units sit within a couple feet of each other for a few minutes to gain a strong connection.
<p>Outdoor temperature is flashing or showing dashes</p>	<p>Flashing of the outdoor temperature may be an indication of wireless interference.</p> <ul style="list-style-type: none"> • Make sure the A-B-C switch in the battery compartments of both the display and sensor are switched to the same letter. You may choose A, B or C; but both units must match to sync up. Sometimes changing to a different channel can help.
<p>Inaccurate forecast</p>	<ul style="list-style-type: none"> • Weather Forecast icon predicts conditions for the next 12 to 24 hours, not current conditions. • Allow unit to run continuously for 33 days. Battery removal or resetting the display will restart Learning Mode. After 14 days, forecast should be fairly accurate, however Learning Mode calibrates for a total of 33 days.

Troubleshooting

Problem	Possible Solution
<p>Display screen not working</p>	<ul style="list-style-type: none"> • Check that the power adapter is plugged into the display and an electrical outlet. • Check that the batteries are installed correctly. Batteries may need to be replaced. • Reset the display by pressing and HOLDING the “RESET” button, located on the back of the display. Date and time will need to be entered after a reset.
<p>Inaccurate temperature or humidity</p>	<ul style="list-style-type: none"> • Make sure both the display and 5-in-1 sensor are placed away from any heat sources or vents (see page 10). • Make sure both units are positioned away from moisture sources (see page 10). • Make sure 5-in-1 sensor is mounted at least 5 ft off of the ground.
<p>No rainfall</p>	<ul style="list-style-type: none"> • Check to ensure the rain gauge stabilizer (plastic tab) has been removed from the bottom of the sensor (see page 7). • Clear debris, such as leaves, out of the rain collector funnel and debris screen. • Calibrate the Rain Gauge (see page 17). • Verify the sensor’s internal tipping lever is moving freely by dripping a little water through the rain collector. You should hear the lever tipping. If you do not hear it, you may need to clean inside the sensor. Video available at www.acurite.com/5in1.
<p>Inaccurate wind readings</p>	<ul style="list-style-type: none"> • What is wind reading being compared to? Pro weather stations are typically mounted at 30 ft high or more. Make sure to compare data using a sensor positioned at the same mounting height. • Check location of the sensor. Ensure it’s mounted a minimum of 5 ft in the air with no obstructions around it (within several feet). • Ensure wind cups are spinning freely. If they hesitate or stop try lubricating with graphite powder or spray lubricant.
<p>If your AcuRite product does not operate properly after trying the troubleshooting steps, visit www.AcuRite.com or call (262) 729-4852 for assistance.</p>	

Care & Maintenance

Display Care

Clean with a soft, damp cloth. Do not use caustic cleaners or abrasives. Keep away from dust, dirt and moisture. Clean ventilation ports regularly with a gentle puff of air.

5-in-1 Sensor Care

Clean the Sensor

Clean with a soft damp cloth. Do not use caustic cleaners or abrasives that will mar the polished surfaces of the rain collection funnel or the solar cell. Scratches will result in decreased performance and reliability.

Insect Prevention

Insects may cause obstructions and interrupt data by nesting in or on the 5-in-1 sensor. To limit this problem, spray the OUTSIDE of the sensor with a household insect repellent. Consult the insect repellent instructions prior to use.

Snow & Freezing Weather

The 5-in-1 sensor will not be damaged by freezing conditions. NOTE: If the rain collector cup fills with snow and then melts, it will register as rain on the display.

Clean the Rain Collector Cup

Remove and empty rain collector debris filter. The debris filter is located in the rain collector funnel. Remove from the top by gently squeezing and pulling out.

Clean the Wind Vane & Anemometer

Remove foreign matter from the outside of the sensor for free movement of the wind vane and anemometer. If needed, use a small amount of spray lubricant, clear silicone or graphite powder on the anemometer for improved movement.

Calibration

The indoor / outdoor temperature and humidity readings, and barometric pressure can be calibrated on the display to improve accuracy. Calibration can improve accuracy when sensor placement or environmental factors impact the data accuracy.

1. To access calibration mode, press AND HOLD the “^”, “v” and “⚙️” buttons simultaneously for at least 5 seconds.
2. To adjust the currently selected (flashing) item, press and release the “^” or “v” buttons to calibrate the data value higher or lower from the actual reading.
3. To save your adjustments, press and release the “⚙️” button to adjust the next preference. The “⚙️” icon will remain illuminated next to calibrated values.

The preference set order is as follows:

OUTDOOR TEMPERATURE

OUTDOOR HUMIDITY

INDOOR TEMPERATURE

INDOOR HUMIDITY

BAROMETRIC PRESSURE (must be set to MANUAL mode to calibrate)*

*To change from AUTO to MANUAL pressure mode and vice versa, press AND HOLD the "⚙️" button for at least 10 seconds. The display indicates the current pressure mode selected, "auto" or "manual".

After 20 seconds of inactivity, the display will save the adjustments and exit calibration mode. Note: Calibrations will be erased if the display is reset or if batteries are removed and the power adapter is unplugged.

Calibrate the Rain Gauge

The rain gauge on the 5-in-1 sensor can be calibrated to improve accuracy.

Items Needed: 5-in-1 sensor, display, plastic cup, pin, screw driver

1. First, ensure 5-in-1 sensor is perfectly level using built-in bubble level.
2. Place display close so you can monitor it during calibration.
3. Make a pin hole in the bottom of a plastic cup. Hold the cup over the rain gauge and fill it with exactly 1 cup (8oz) of water, allowing the water to drip into the rain gauge. You should hear the internal buckets tip and see water drain through the rain gauge.
4. A few seconds after each bucket tip, the display displays rainfall in approximately 0.01" or more increments.
5. The cup of water should take more than 20 minutes to empty; a quicker period will result in inaccurate calibration. Try to simulate a normal steady rainfall. When cup is empty of water, display should register 1.06"

Tips

- There should be nearly an equal number of water drops (about 25 water drops) between bucket tips. If not, adjust the calibration screws on the bottom of the 5-in-1 sensor until an equal number of water drops are tipping the buckets. Then, restart the calibration procedure.
- If you don't hear the buckets tipping and see water dripping alternately out of each drain, there may be an issue with the rain gauge or it's adjustment. See Troubleshooting on page 15.

Adjustment

If the rain gauge doesn't register close to 1.06", make an EQUAL adjustment to the two calibration screws on the bottom of the 5-in-1 sensor. Turning screws clockwise increases rainfall; counter clockwise decreases rainfall.

- To adjust the rainfall reading by 2% turn both screws 1/8 of a turn.
- To adjust the rainfall reading by 4% turn both screws 1/4 of a turn.
- To adjust the rainfall reading by 8% turn both screws 1/2 of a turn.

Watch the video at: www.acurite.com/5in1

Specifications

TEMPERATURE RANGE	Outdoor: -40°F to 158°F; -40°C to 70°C
	Indoor: 32°F to 122°F; 0°C to 50°C
HUMIDITY RANGE	Outdoor: 1% to 99%
	Indoor: 1% to 99%
WIND SPEED	0 to 99 mph; 0 to 159 kph
WIND DIRECTION INDICATORS	16 points
RAINFALL	0.01 inches (0.25 mm) and up
WIRELESS RANGE	330ft / 100m depending on home construction materials
OPERATING FREQUENCY	433 MHz
POWER	Display: 5v, 250mA power adapter 3 x AAA alkaline batteries (optional)
	Sensor: 4 x AA alkaline or lithium batteries
DATA REPORTING	Wind Speed: 18 second updates; Direction: 36 seconds Outdoor temperature & humidity: 36 second updates Indoor temperature & humidity: 60 second updates

FCC Information

This device complies with part 15 of FCC rules. Operation is subject to the following two conditions:

1- This device may NOT cause harmful interference, and

2- This device must accept any interference received, including interference that may cause undesired operation.

WARNING: Changes or modifications to this unit not expressly approved by the party responsible for compliance could void the user's authority to operate the equipment.

NOTE: This equipment has been tested and found to comply with the limits for a Class B digital device, pursuant to Part 15 of the FCC rules. These limits are designed to provide reasonable protection against harmful interference in a residential installation. This equipment generates, uses and can radiate radio frequency energy and, if not installed and used in accordance with the instructions, may cause harmful interference to radio communications. However, there is no guarantee that interference will not occur in a particular installation. If this equipment does cause harmful interference to radio or television reception, which can be determined by turning the equipment off and on, the user is encouraged to try to correct the interference by one or more of the following measures:

- Reorient or relocate the receiving antenna.
- Increase the separation between the equipment and the receiver.
- Connect the equipment into an outlet on a circuit different from that to which the receiver is connected.
- Consult the dealer or an experienced radio/TV technician for help.

NOTE: The manufacturer is not responsible for any radio or TV interference caused by unauthorized modifications to this equipment. Such modifications could void the user authority to operate the equipment.

This device complies with Industry Canada licence-exempt RSS standard(s).

Operation is subject to the following two conditions:

(1) This device may not cause interference, and

(2) This device must accept any interference received, including interference that may cause undesired operation of the device.

Customer Support

AcuRite customer support is committed to providing you with best-in-class service. **For assistance**, please have the model number of this product available and contact us in any of the following ways:



(262) 729-4852

Visit us at www.AcuRite.com

- ▶ Installation Videos
- ▶ Register your Product
- ▶ Instruction Manuals
- ▶ Support User Forum
- ▶ Replacement Parts
- ▶ Submit Feedback & Ideas

IMPORTANT

PRODUCT MUST BE REGISTERED
TO RECEIVE WARRANTY SERVICE

PRODUCT REGISTRATION

Register online to receive 1 year warranty protection

www.AcuRite.com

Limited 1-Year Warranty

AcuRite is a wholly owned subsidiary of Chaney Instrument Company. For purchases of AcuRite products, AcuRite provides the benefits and services set forth herein. For purchases of Chaney products, Chaney provides the benefits and services set forth herein.

We warrant that all products we manufacture under this warranty are of good material and workmanship and, when properly installed and operated, will be free of defects for a period of one year from the date of purchase.

Any product which, under normal use and service, is proven to breach the warranty contained herein within ONE YEAR from date of sale will, upon examination by us, and at our sole option, be repaired or replaced by us. Transportation costs and charges for returned goods shall be paid for by the purchaser. We hereby disclaim all responsibility for such transportation costs and charges. This warranty will not be breached, and we will give no credit for products which have received normal wear and tear not affecting the functionality of the product, been damaged (including by acts of nature), tampered, abused, improperly installed, or repaired or altered by others than our authorized representatives.

Remedy for breach of this warranty is limited to repair or replacement of the defective item(s). If we determine that repair or replacement is not feasible, we may, at our option, refund the amount of the original purchase price.

THE ABOVE-DESCRIBED WARRANTY IS THE SOLE WARRANTY FOR THE PRODUCTS AND IS EXPRESSLY IN LIEU OF ALL OTHER WARRANTIES, EXPRESS OR IMPLIED. ALL OTHER WARRANTIES OTHER THAN THE EXPRESS WARRANTY SET FORTH HEREIN ARE HEREBY EXPRESSLY DISCLAIMED, INCLUDING WITHOUT LIMITATION THE IMPLIED WARRANTY OF MERCHANTABILITY AND THE IMPLIED WARRANTY OF FITNESS FOR A PARTICULAR PURPOSE.

We expressly disclaim all liability for special, consequential, or incidental damages, whether arising in tort or by contract from any breach of this warranty. Some states do not allow the exclusion or limitation of incidental or consequential damages, so the above limitation or exclusion may not apply to you.

We further disclaim liability from personal injury relating to our products to the extent permitted by law. By acceptance of any of our products, the purchaser assumes all liability for the consequences arising from their use or misuse. No person, firm or corporation is authorized to bind us to any other obligation or liability in connection with the sale of our products. Furthermore, no person, firm or corporation is authorized to modify or waive the terms of this warranty unless done in writing and signed by a duly authorized agent of ours.

In no case shall our liability for any claim relating to our products, your purchase or your use thereof, exceed the original purchase price paid for the product.

Applicability of Policy

This Return, Refund, and Warranty Policy applies only to purchases made in the United States and Canada. For purchases made in a country other than the United States or Canada, please consult the policies applicable to the country in which you made your purchase.

Additionally, this Policy applies only to the original purchaser of our products. We cannot and do not offer any return, refund, or warranty services if you buy products used or from resale sites such as eBay or Craigslist.

Governing Law

This Return, Refund, and Warranty Policy is governed by the laws of the United States and the State of Wisconsin. Any dispute relating to this Policy shall be brought exclusively in the federal or State courts having jurisdiction in Walworth County, Wisconsin; and purchaser consents to jurisdiction within the State of Wisconsin.

ACU RITE®



Weather
Stations



Temperature
& Humidity



Weather
Alert Radio



Kitchen
Thermometers
& Timers



Clocks

It's More than Accurate, it's ACU RITE.

AcuRite offers an extensive assortment of precision instruments, designed to provide you with information you can depend on to Plan your day with confidence™.

www.AcuRite.com

©Chaney Instrument Co. All rights reserved. AcuRite is a registered trademark of the Chaney Instrument Co., Lake Geneva, WI 53147. All other trademarks and copyrights are the property of their respective owners. AcuRite uses patented technology. Visit www.AcuRite.com/patents for details.